

[www.esc.guide/bulldock](http://www.esc.guide/bulldock)

## BULDOCK

Floating Docks / Jet Sliders / Boat Sliders / Marinas

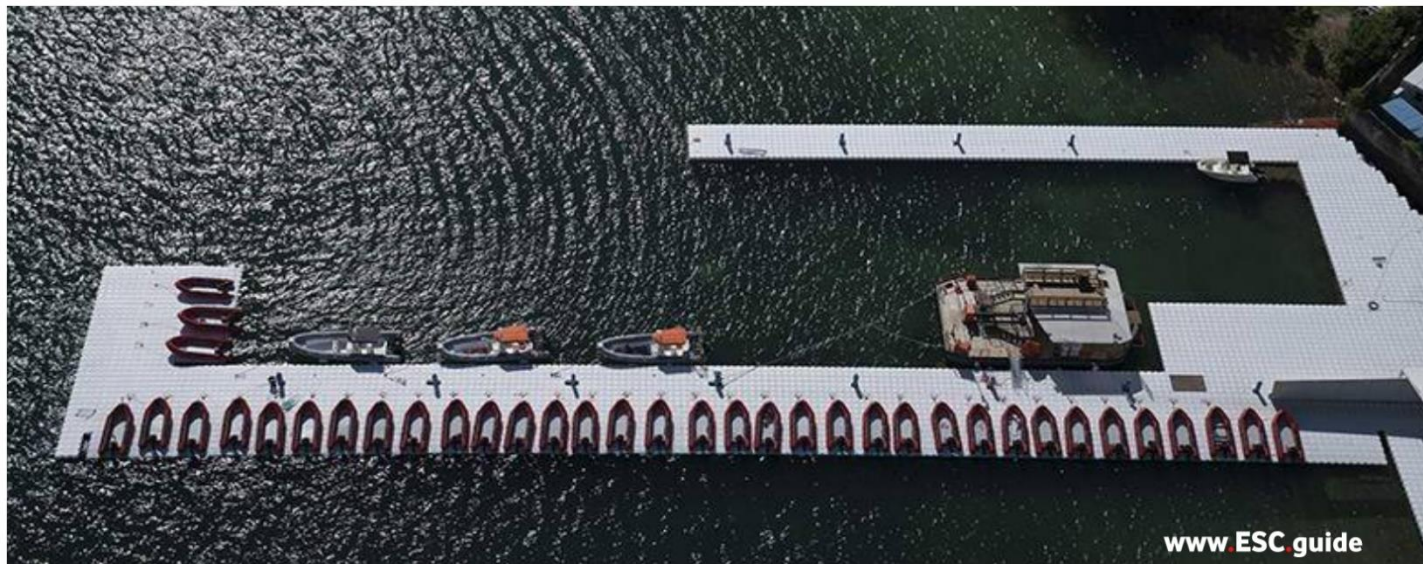

			PAGES
PART 1	Turnkey Solutions	Jet Slider	3-11
PART 2	Turnkey Solutions	Boat Slider	12-21
PART 3	Custom Solutions	Pontoons, Docks & Marinas	22-58
	Case Studies	Ideas	59-61

### More Information:

Web Link Presentation: <https://www.esc.guide/bulldock>

Official Web Site: <https://bulldock.com>

## The System

Our floating system is designed to be simple: the blocks are held together strongly and firmly by specially designed mounting screws. All pieces are lightweight and provide easy handling.

The cubes are suitable for any shoreline. They are adaptable and can be assembled to create any shape and size - no limit for the configuration options!

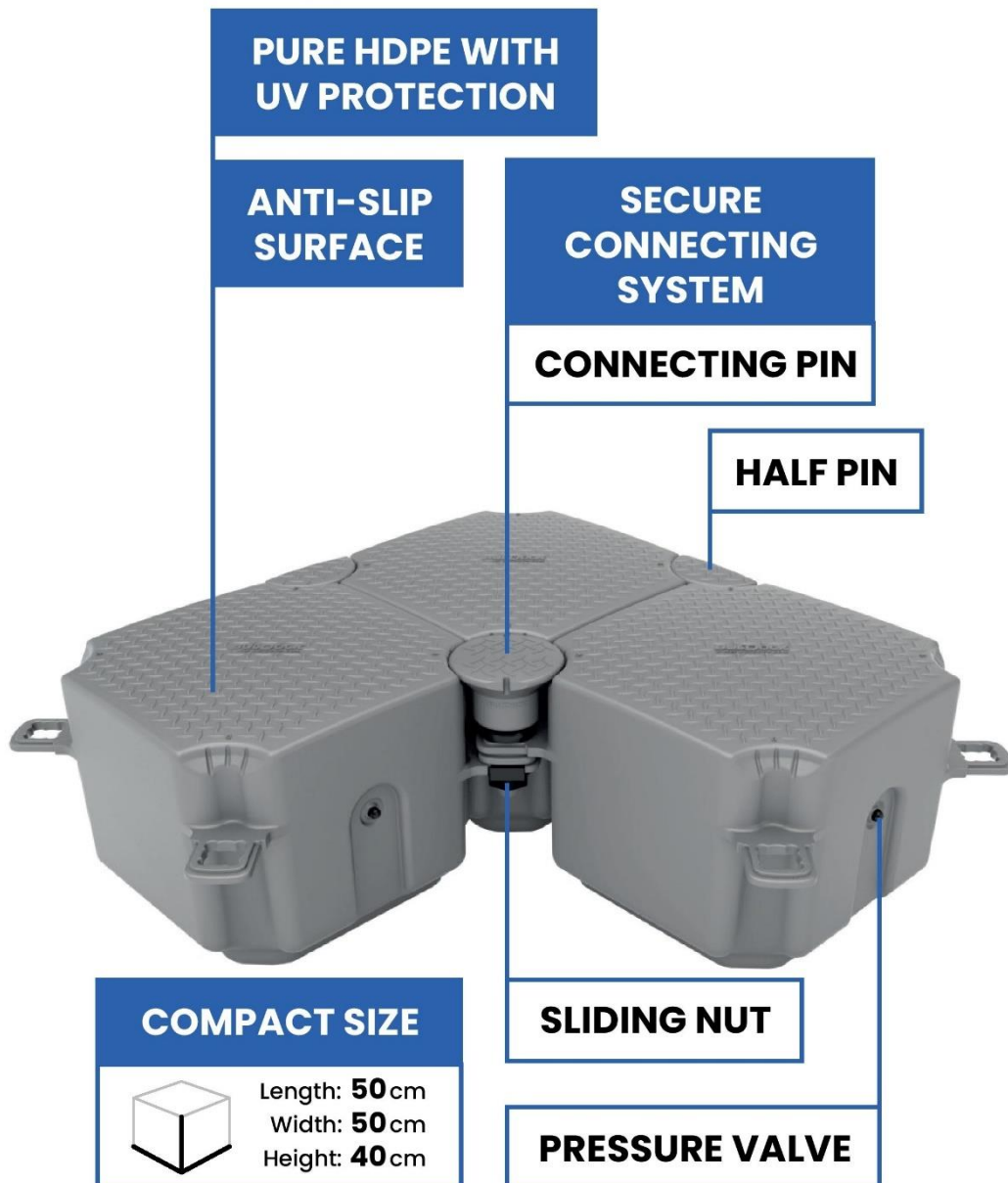

[www.esc.guide/bulldock](http://www.esc.guide/bulldock)



# Jet Sliders

<https://www.esc.guide/post/jet-slider>



# Jet Sliders

The **Jet Slider** is made of efficient new-generation HDPE (high-density polyethylene).



**BulDock Jet Slider** is a unique dry dock system.

The **Jet Slider** is lightweight, but thanks to its' technology, it is resistant to impact, chemical products, UV rays and severe weather conditions.

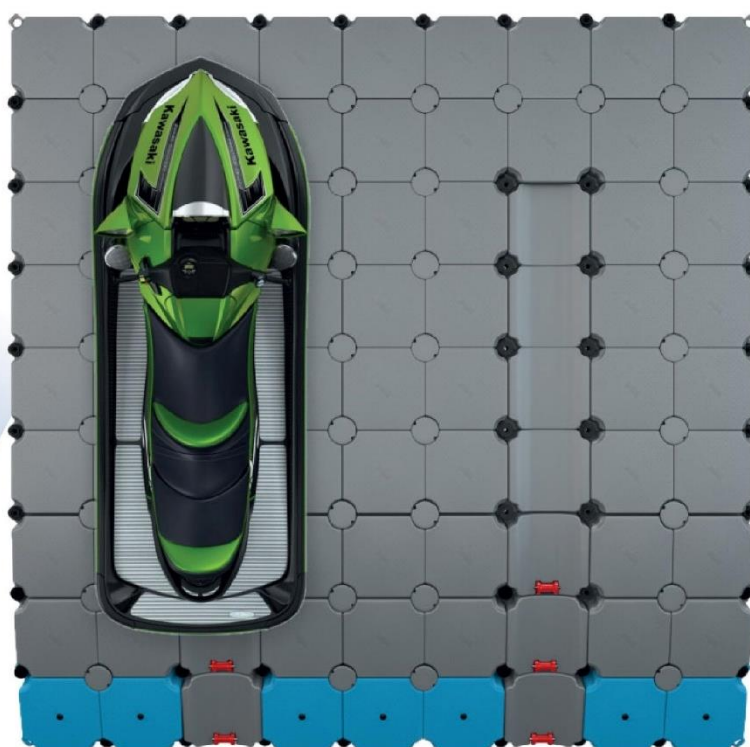

Its' exceptional design prevents any disproportionate strain on the hull by distributing the watercraft's weight evenly.

The **Jet Slider** does not feature any moving parts that might be damaged or would require maintenance.

www.esc.guide/bulldock

**Jet Slider 350**

Price:

**1 360,00 €**

Material / Composition: High-density Polyethylene (HDPE)  
 Rollers: Polyurethane, Inox Steel  
 Surface: Anti-Slip  
 Dimensions: 350 x 150 x 27 cm (Length/Width/Height)  
 Weight: 135 kg

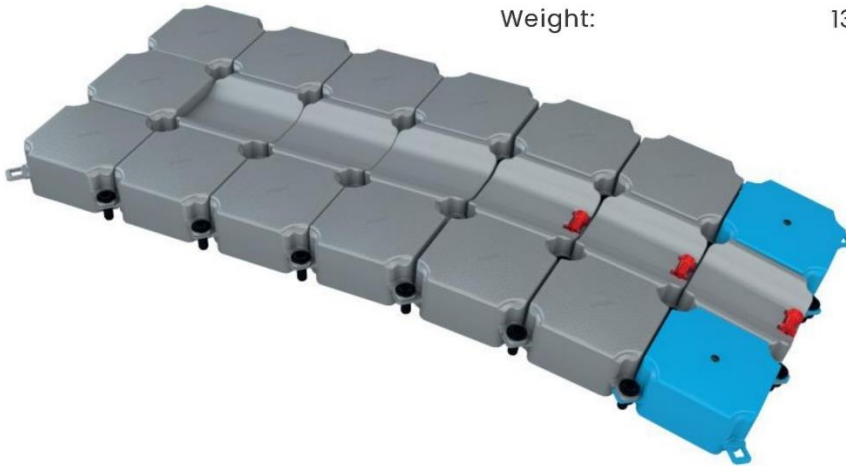

Grey

2018BG015

Beige

2018BG016

\*Any colour per customers wishes

**Jet Slider 400  
Big Size**

Price:

**1 600,00 €**

Material / Composition: High-density Polyethylene (HDPE)  
 Rollers: Polyurethane, Inox Steel  
 Surface: Anti-Slip  
 Dimensions: 400 x 150 x 40 cm (Length/Width/Height)  
 Weight: 180 kg

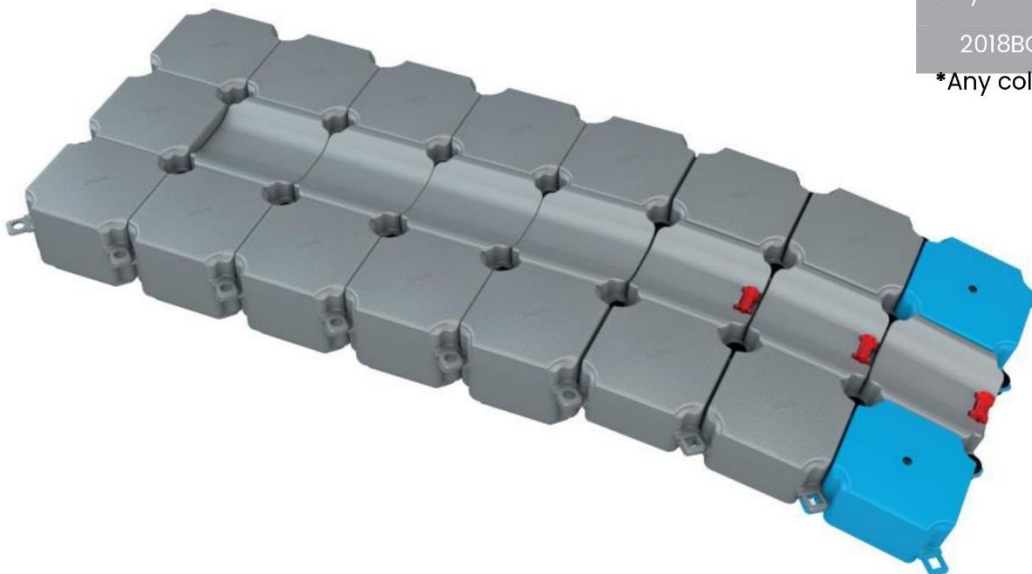

Grey

2018BG017

Beige

2018BG018

\*Any colour per customers wishes

www.esc.guide/bulldock

**Jet Slider Twin450**

Price:

**5 050,00 €**

Material / Composition: High-density Polyethylene (HDPE)  
 Rollers: Polyurethane, Inox Steel  
 Surface: Anti-Slip  
 Dimensions: 450 x 450 x 40 cm (Length/Width/Height)  
 Weight: 540 kg

Grey

2018BG019

Beige

2018BG020

\*Any colour per customers wishes

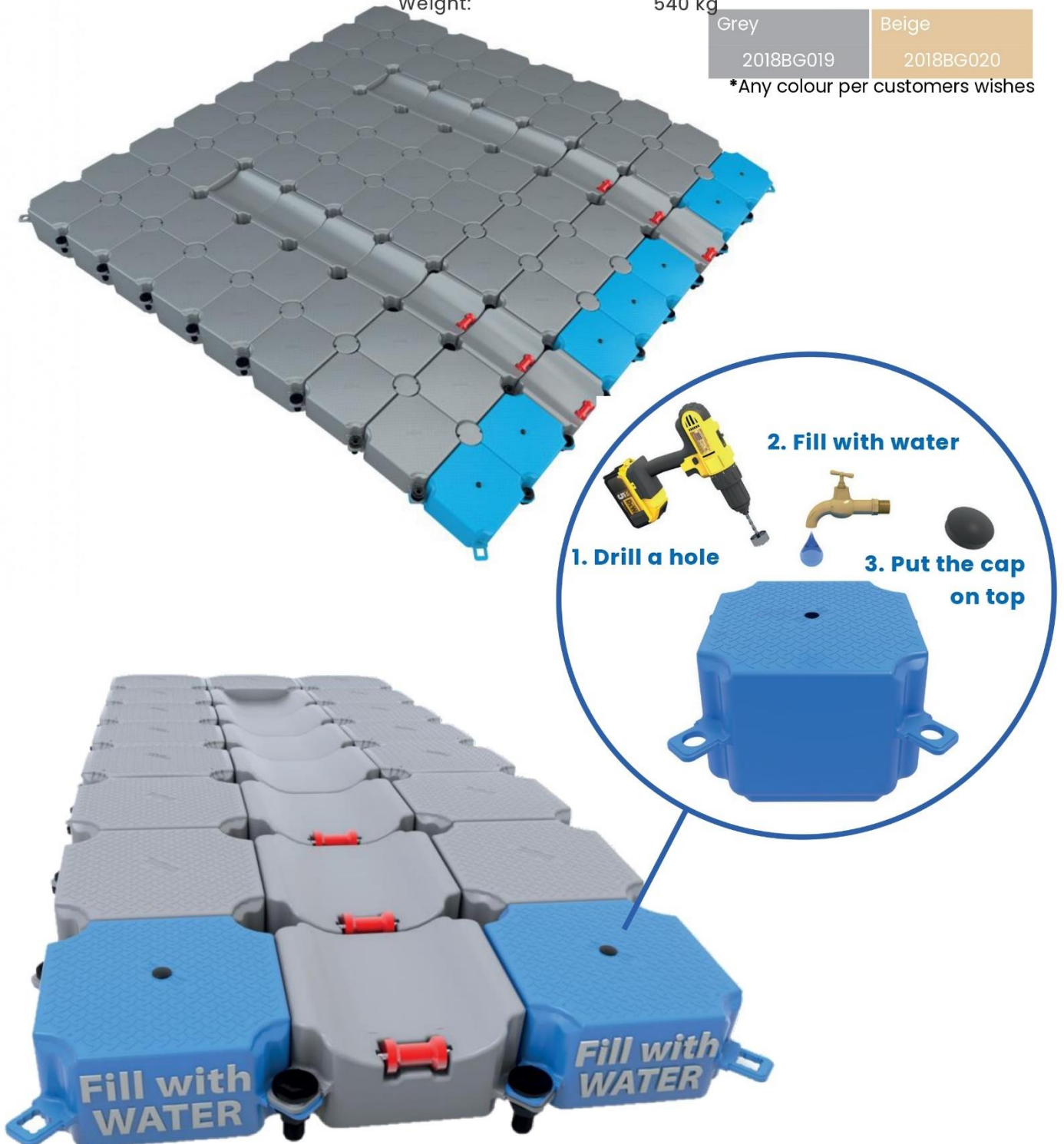

[www.esc.guide/buldock](http://www.esc.guide/buldock)

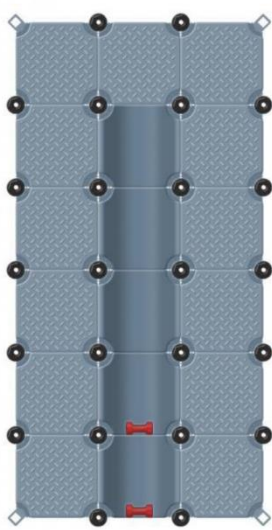

**Jet Slider 300 H27**

Price: **1150,00 €**

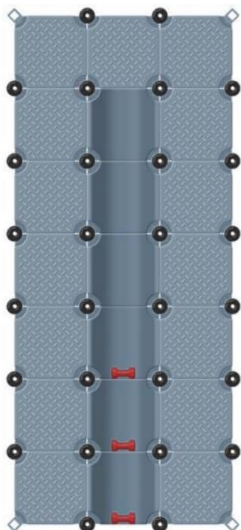

**Jet Slider 350 H27**

Price: **1360,00 €**

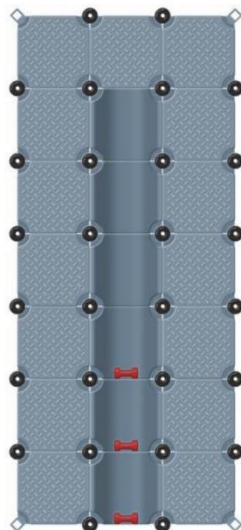

**Jet Slider 350 H40**

Price: **1400,00 €**

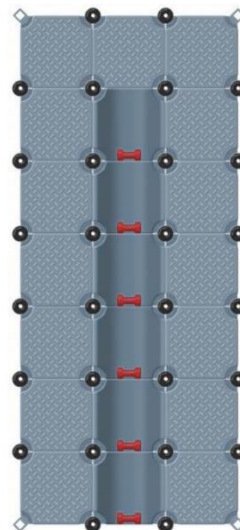

**Jet Slider 350 H40 R**

Price: **1500,00 €**

**BULDOCK**

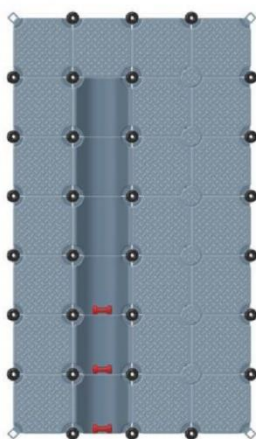

**Jet Slider 350 H27 L**

Price: **1750,00 €**

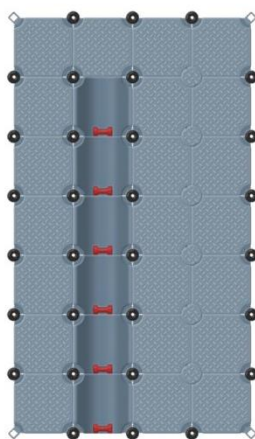

**Jet Slider 350 H27 R L**

Price: **1840,00 €**

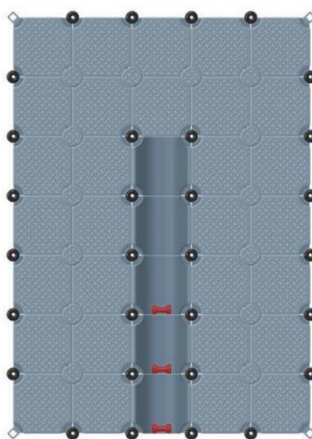

**Jet Slider 350 H27 XL**

Price: **2120,00 €**

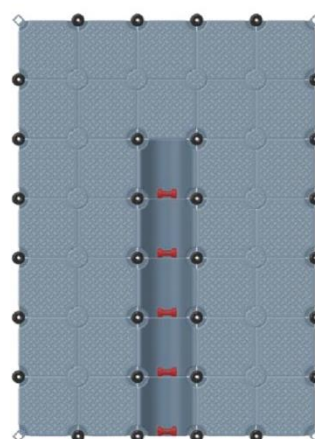

**Jet Slider 350 H27 R XL**

Price: **2180,00 €**



[www.esc.guide/buldock](http://www.esc.guide/buldock)

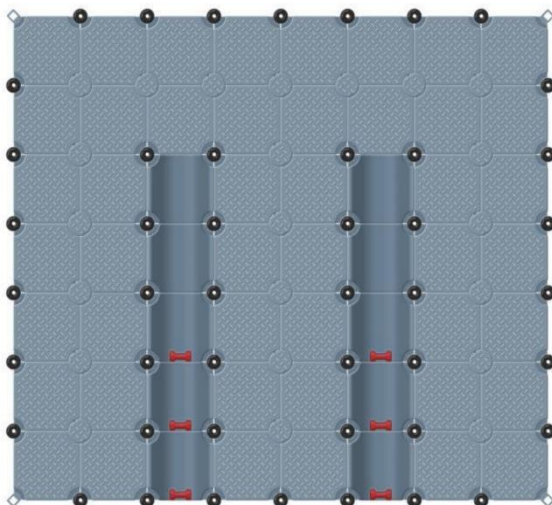

**Jet Slider 350 Twin H27**  
Price: **3 450,00 €**

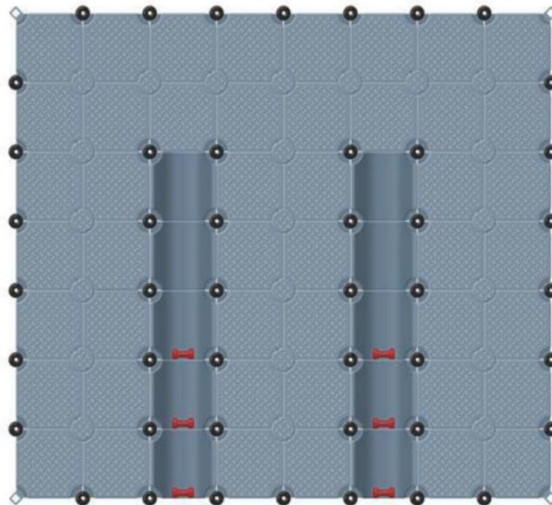

**Jet Slider 350 Twin H40**  
Price: **3 550,00 €**

**BULDOCK**

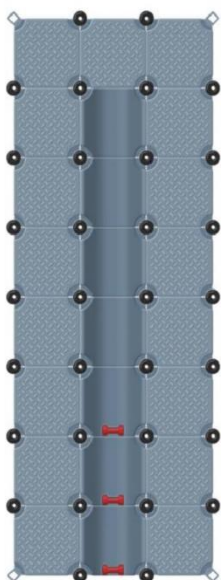

**Jet Slider 400**  
Price: **1 600,00 €**

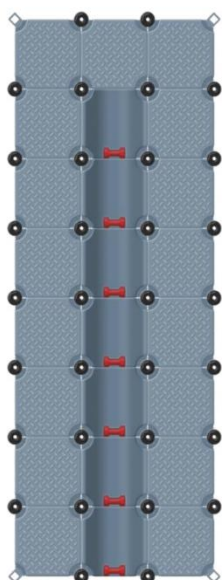

**Jet Slider 400 R**  
Price: **1 720,00 €**

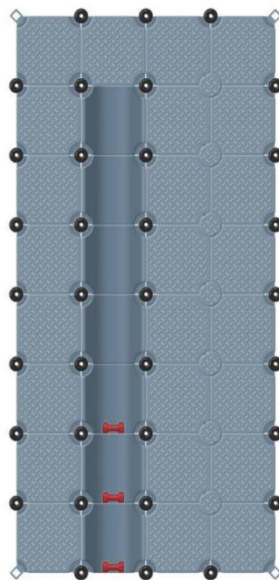

**Jet Slider 400 L**  
Price: **2 050,00 €**

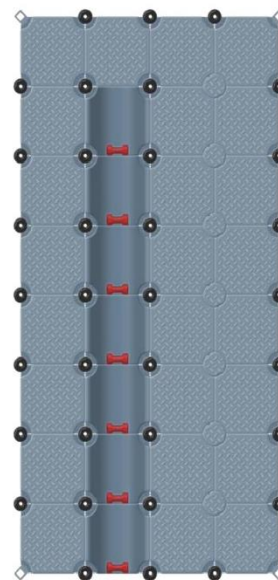

**Jet Slider 400 R L**  
Price: **2 180,00 €**

[www.esc.guide/bulldock](http://www.esc.guide/bulldock)

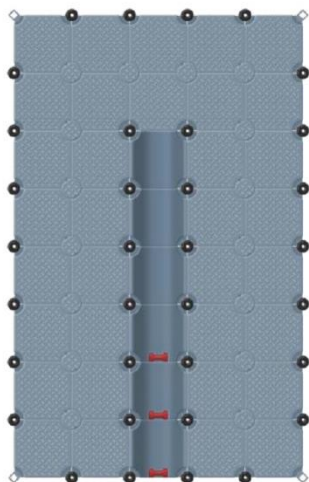

**Jet Slider 400 XL**

Price: **2 490,00 €**

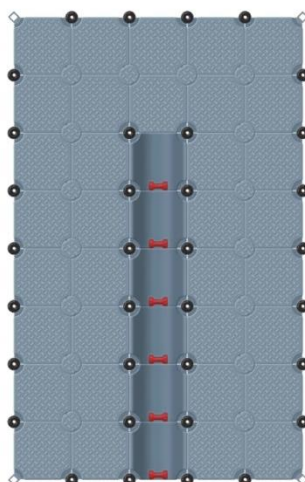

**Jet Slider 400 R XL**

Price: **2 580,00 €**

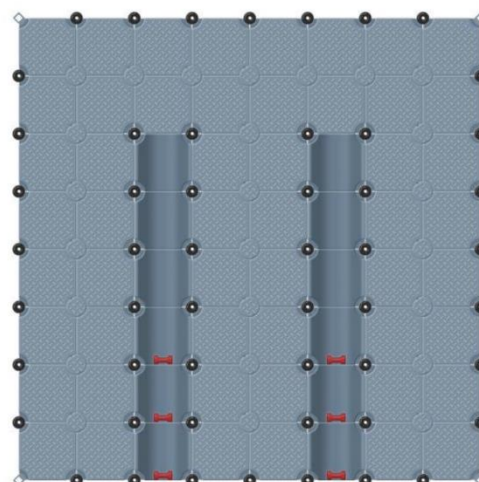

**Jet Slider 400 Twin**

Price: **4 040,00 €**

**BULDOCK**

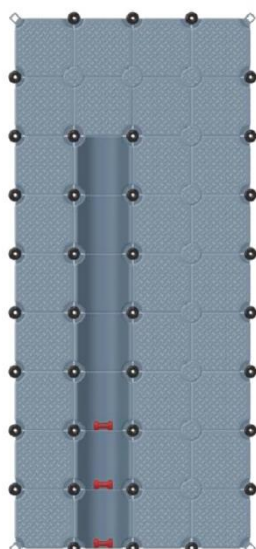

**Jet Slider 450 L**

Price: **2 290,00 €**

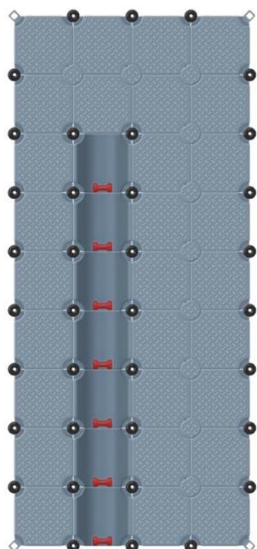

**Jet Slider 450 R L**

Price: **2 410,00 €**

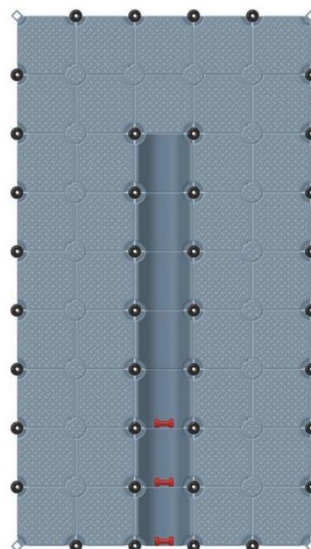

**Jet Slider 450 XL**

Price: **2 800,00 €**

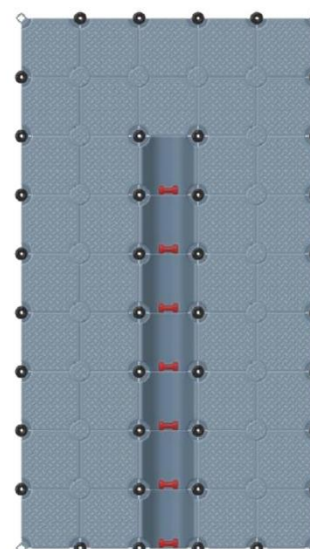

**Jet Slider 450 R XL**

Price: **2 920,00 €**

[www.esc.guide/bulldock](http://www.esc.guide/bulldock)

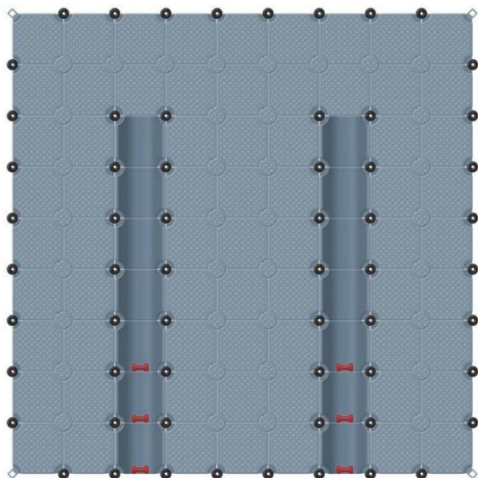

**Jet Slider 450 Twin**

Price: **5 050,00 €**

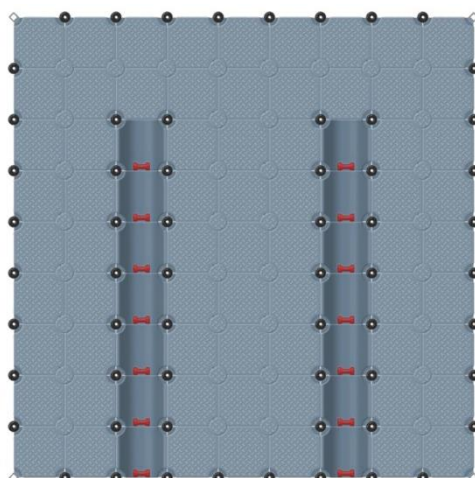

**Jet Slider 450 R Twin**

Price: **5 300,00 €**

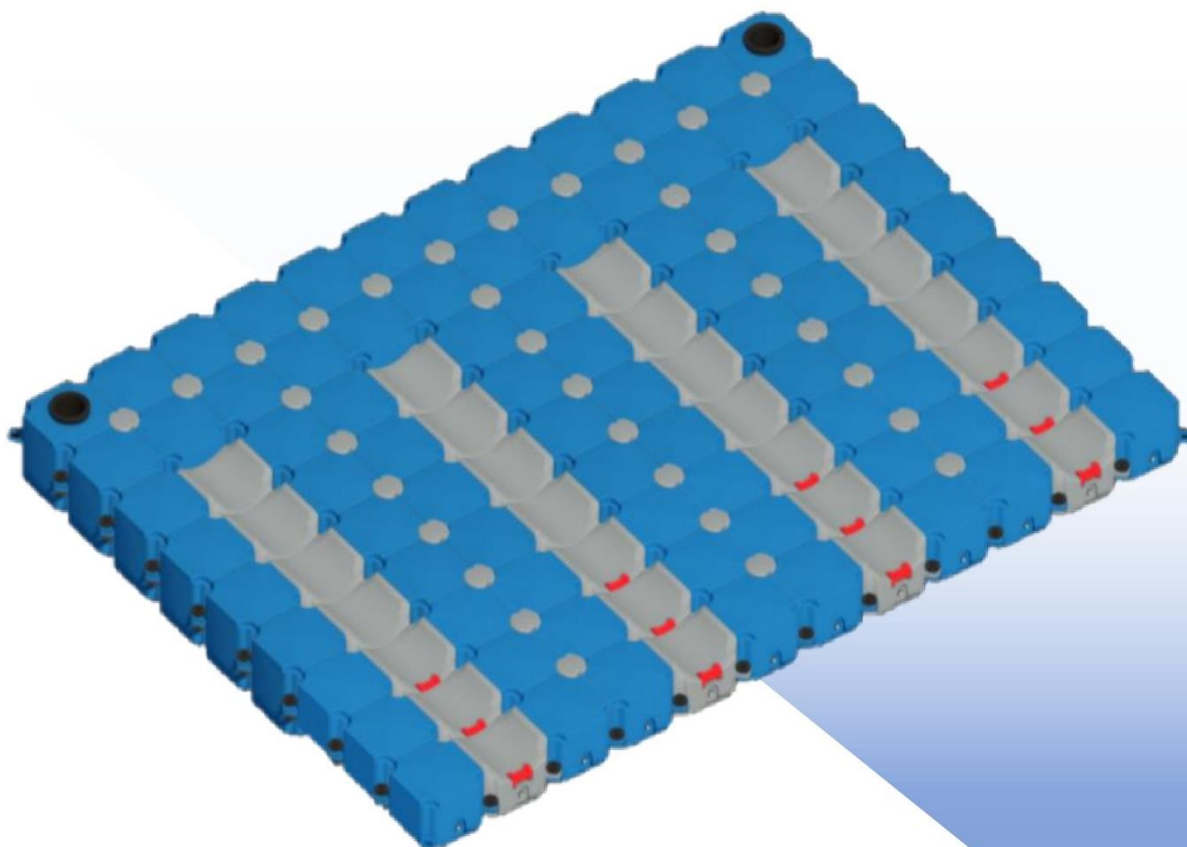

[www.esc.guide/bulldock](http://www.esc.guide/bulldock)



# Boat Sliders

<https://www.esc.guide/post/boat-sliders>



**BULDOCK**  
FLOATING DOCKS

## Boat Sliders

**BulDock's Boat Slider** is a unique dry-dock system. Its' exceptiona design prevents any disproportionate strain on the hull by distributing the watercraft's weight evenly. The Boat Slider does not feature any moving parts that might be damaged or would require maintenance. The **BulDock Boat Slider** is lightweight, resistant to UV rays, chemicals and collision.



**V - Boat Sliders**

**Boat Slider V-Slide  
550 & 650**

Model:	Price:
BS V-SLIDE 550	<b>3 650,00 €</b>
BS V-SLIDE 650	<b>4 320,00 €</b>

Material / Composition: High-density Polyethylene (HDPE)  
 Rollers: Polyurethane, Inox Steel  
 Surface: Anti-Slip  
 Dimensions: 550/650 x250x40 cm (Length/Width/Height)  
 Weight: 390 / 465 kg

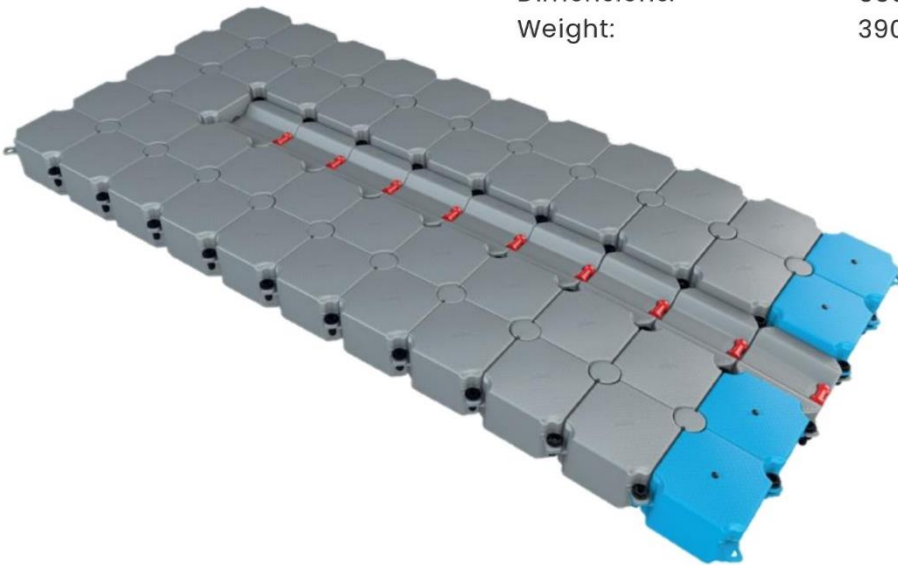

Grey 2018BG021	Beige 2018BG022
Grey 2018BG023	Beige 2018BG024

**Boat Slider V-Slide  
850 L & 1050 L**

Model:	Price:
BS V-SLIDE 850 L	<b>7 620,00 €</b>
BS V-SLIDE 1050 L	<b>9 430,00 €</b>

Material / Composition: High-density Polyethylene (HDPE)  
 Rollers: Polyurethane, Inox Steel  
 Surface: Anti-Slip  
 Dimensions: 850/1050 x350x40 cm (Length/Width/Height)  
 Weight: 850 / 1050 kg

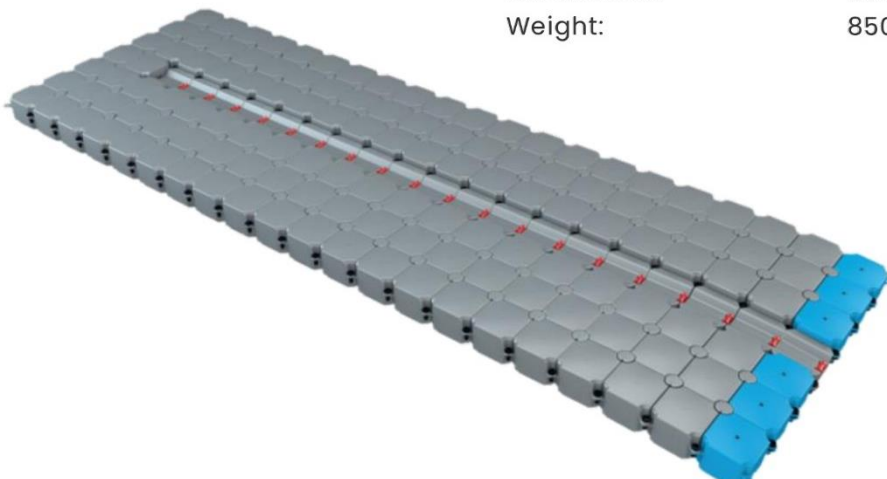

Grey 2020BG025	Beige 2020BG026
Grey 2020BG027	Beige 2020BG028

[www.esc.guide/bulldock](http://www.esc.guide/bulldock)

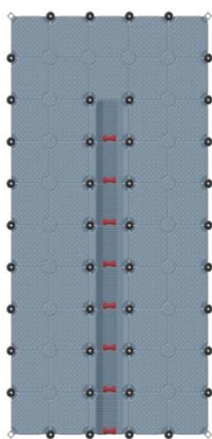

**Boat Slider V-Slide 500**

Price: **3 310,00 €**

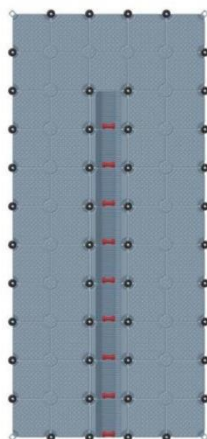

**Boat Slider V-Slide 550**

Customer: **3 650,00 €**

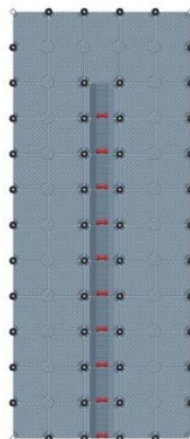

**Boat Slider V-Slide 600**

Customer: **3 980,00 €**

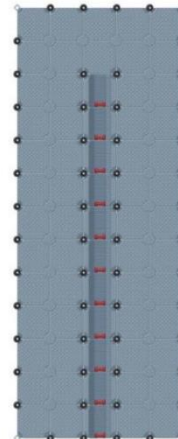

**Boat Slider V-Slide 650**

Customer: **4 320,00 €**

**BULLDOCK**

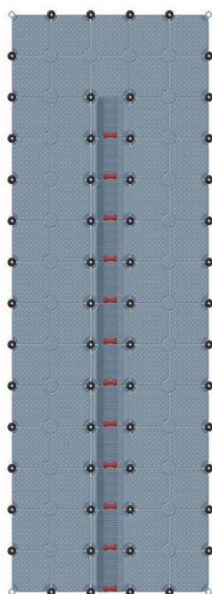

**Boat Slider V-Slide 700**

Price: **4 660,00 €**

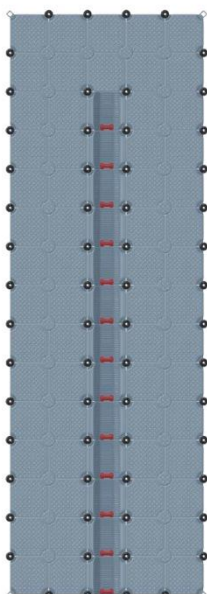

**Boat Slider V-Slide 750**

Price: **5 000,00 €**

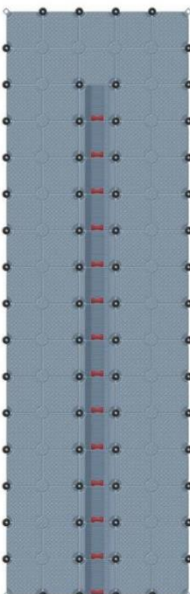

**Boat Slider V-Slide 800**

Price: **5 340,00 €**

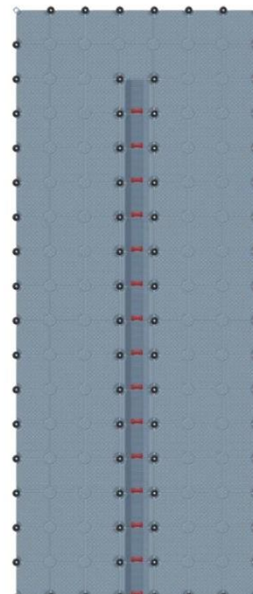

**Boat Slider V-Slide 850 L**

Price: **7 620,00 €**

[www.esc.guide/buldock](http://www.esc.guide/buldock)

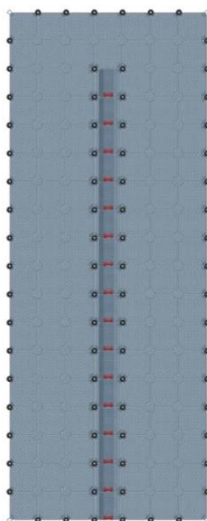

**Boat Slider V-Slide 900 L**

Price: **8 070,00 €**

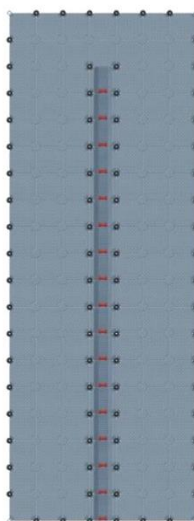

**Boat Slider V-Slide 950 L**

Price: **8 530,00 €**

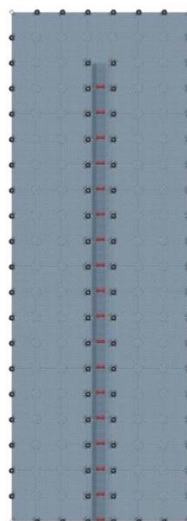

**Boat Slider V-Slide 1000 L**

Price: **8 980,00 €**



**Boat Slider V-Slide 1050 L**

Price: **9 430,00 €**

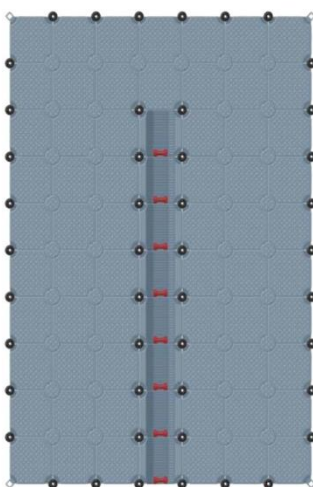

**Boat Slider V-Slide 500 L**

Price: **4 460,00 €**

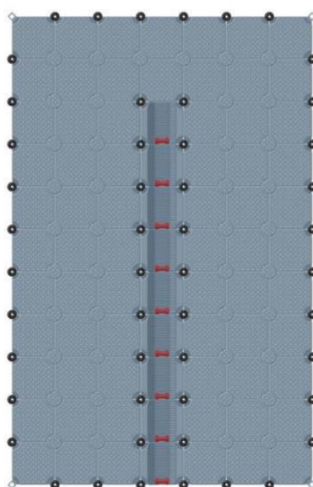

**Boat Slider V-Slide 550 L**

Price: **4 910,00 €**

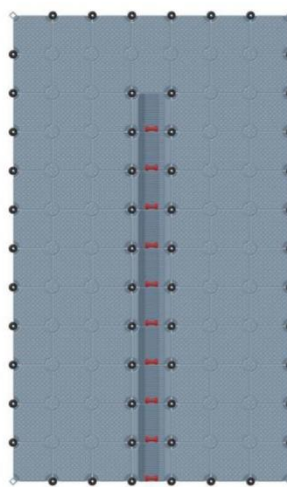

**Boat Slider V-Slide 600 L**

Price: **5 360,00 €**

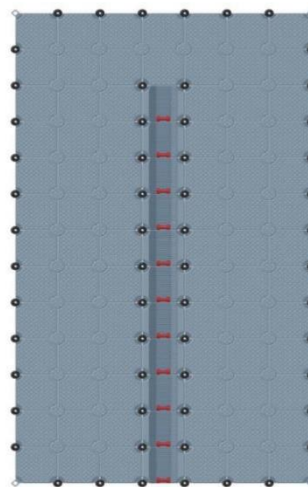

**Boat Slider V-Slide 650 L**

Price: **5 820,00 €**



[www.esc.guide/buldock](http://www.esc.guide/buldock)

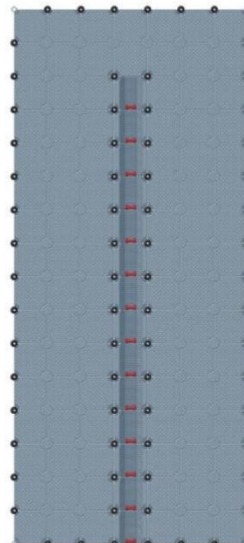
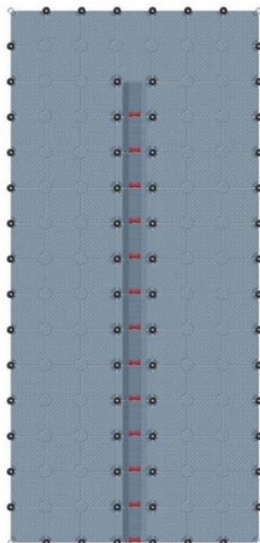
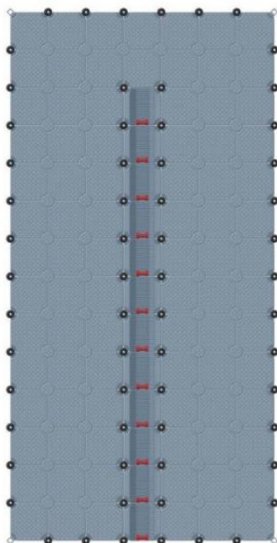

**Boat Slider V-Slide 700 L**

Price: **6 273,00 €**

**Boat Slider V-Slide 750 L**

Price: **6 724,00 €**

**Boat Slider V-Slide 800 L**

Price: **7 170,00 €**

**BULDOCK**

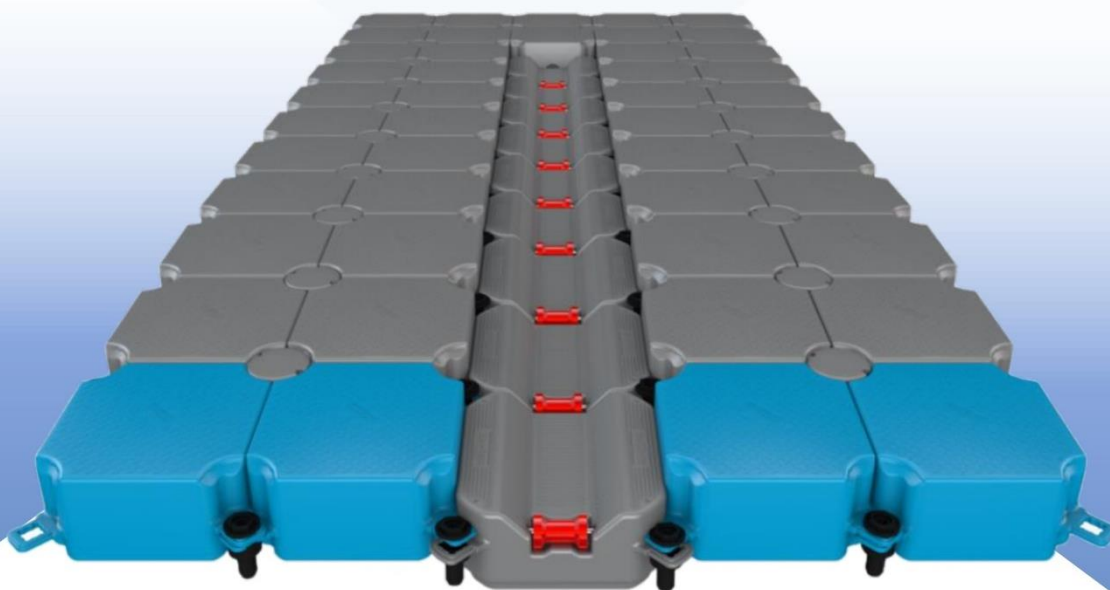

**U - Boat Sliders**

**Boat Slider U-Slide  
550 & 650**

Model:	Price:
BS U-SLIDE 550	<b>3 270,00 €</b>
BS U-SLIDE 650	<b>3 900,00 €</b>

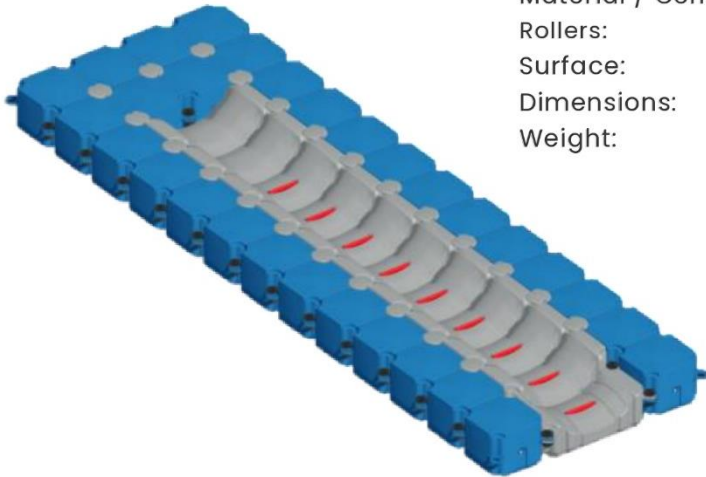

Material / Composition: High-density Polyethylene (HDPE)  
 Rollers: Polyurethane, Inox Steel  
 Surface: Anti-Slip  
 Dimensions: 550/650 x200x40 cm (Length/Width/Height)  
 Weight: 303 / 357 kg

Grey	Grey
2021BG007 550	2021BG009 650

**Boat Slider U-Slide  
850 L & 1050 L**

Model:	Price:
BS U-SLIDE 850 L	<b>7 100,00 €</b>
BS U-SLIDE 1050 L	<b>8 810,00 €</b>

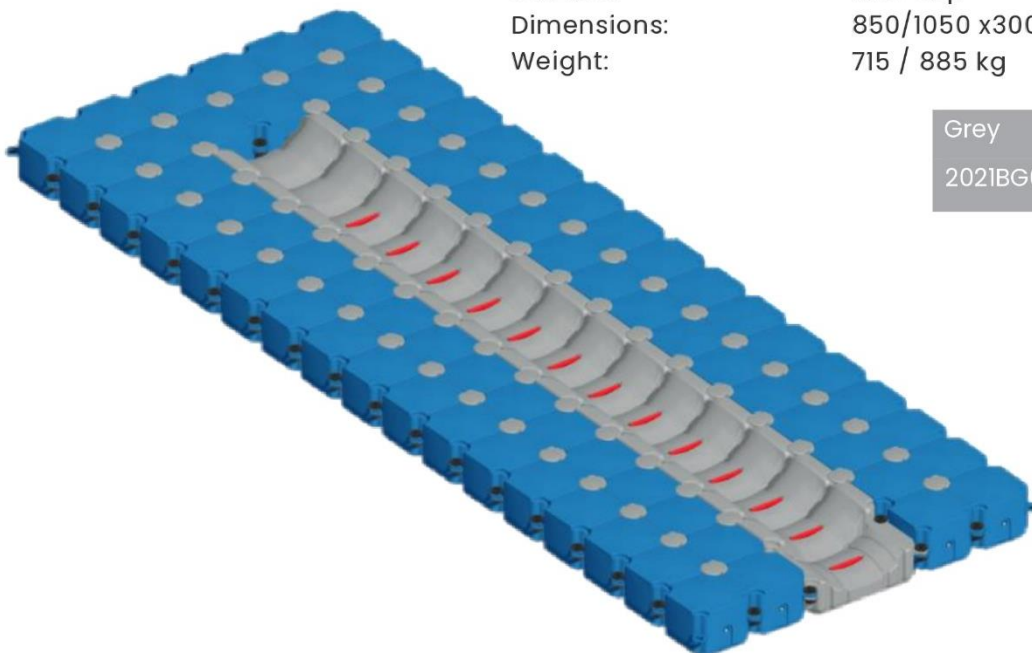

Material / Composition: High-density Polyethylene (HDPE)  
 Rollers: Polyurethane, Inox Steel  
 Surface: Anti-Slip  
 Dimensions: 850/1050 x300x40 cm (Length/Width/Height)  
 Weight: 715 / 885 kg

Grey	Grey
2021BG011 850	2021BG013 1050

[www.esc.guide/buldock](http://www.esc.guide/buldock)

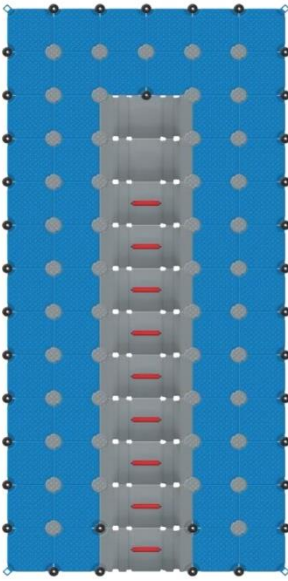

**Boat Slider U-Slide 650 L**

Price: **5 390,00 €**

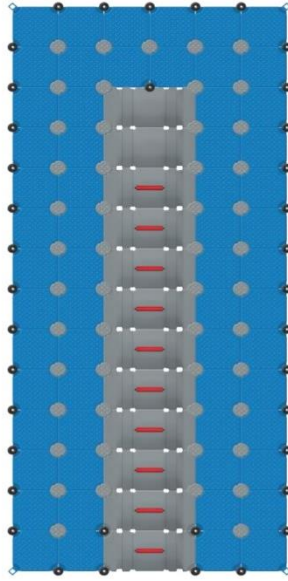

**Boat Slider U-Slide 700 L**

Price: **5 820,00 €**

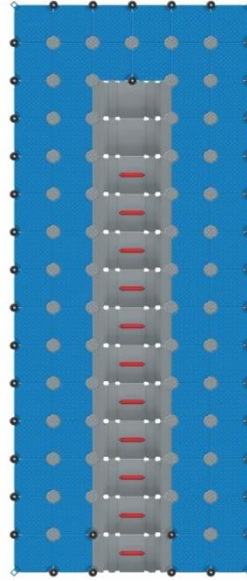

**Boat Slider U-Slide 750 L**

Price: **6 240,00 €**

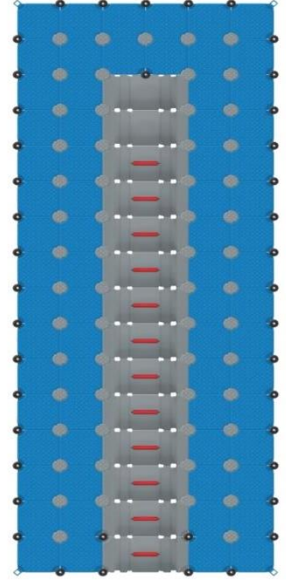

**Boat Slider U-Slide 800 L**

Price: **6 670,00 €**

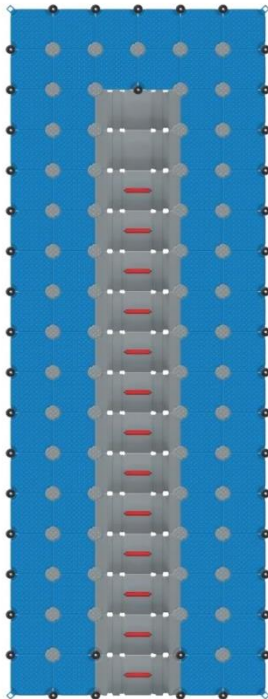

**Boat Slider U-Slide 850 L**

Price: **7 100,00 €**

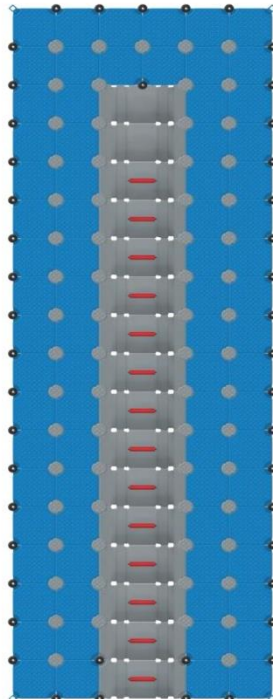

**Boat Slider U-Slide 900 L**

Price: **7 530,00 €**

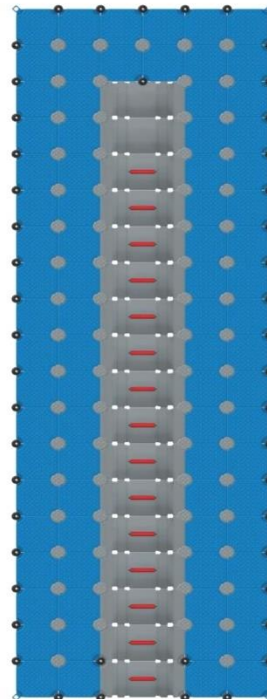

**Boat Slider U-Slide 950 L**

Price: **7 950,00 €**

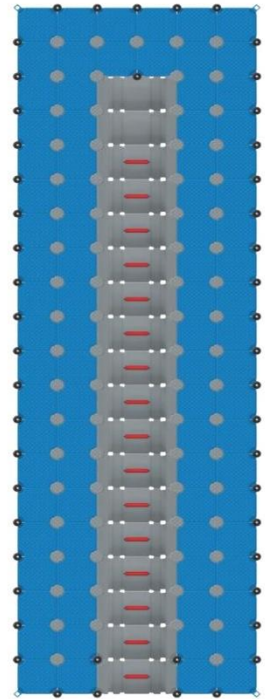

**Boat Slider U-Slide 1000 L**

Price: **8 380,00 €**

[www.esc.guide/bulldock](http://www.esc.guide/bulldock)

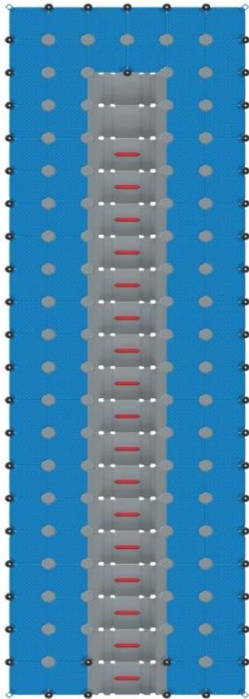

**Boat Slider U-Slide 1050 L**

Price: **8 810,00 €**

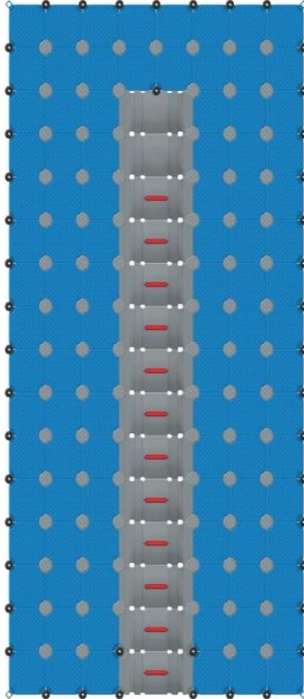

**Boat Slider U-Slide 800 XL**

Price: **8 500,00 €**

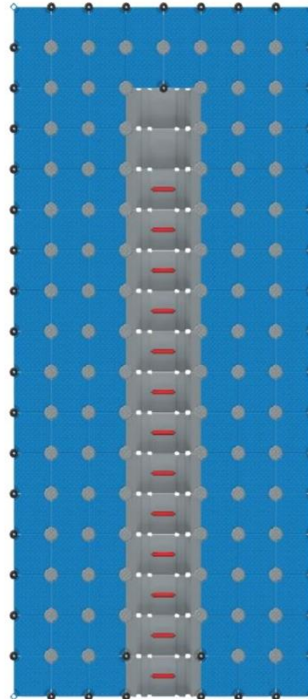

**Boat Slider U-Slide 850 XL**

Price: **9 040,00 €**

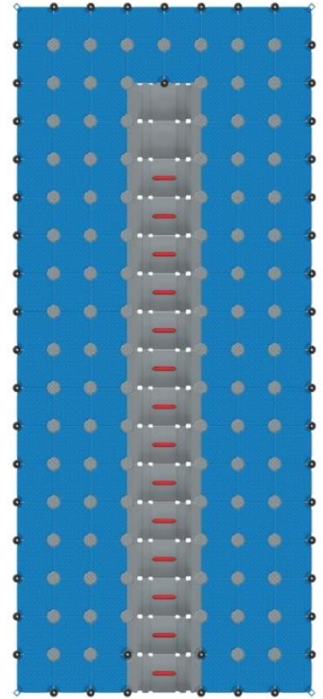

**Boat Slider U-Slide 900 XL**

Price: **9 580,00 €**

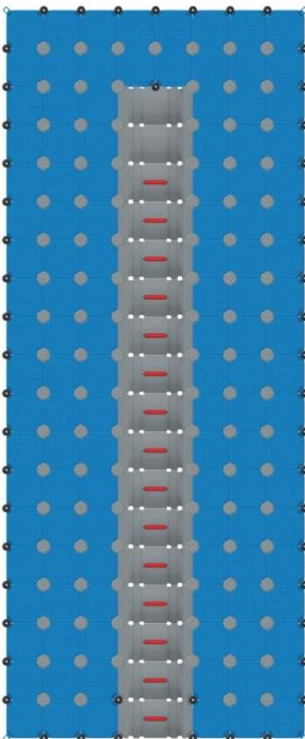

**Boat Slider U-Slide 950 XL**

Price: **10 120,00 €**

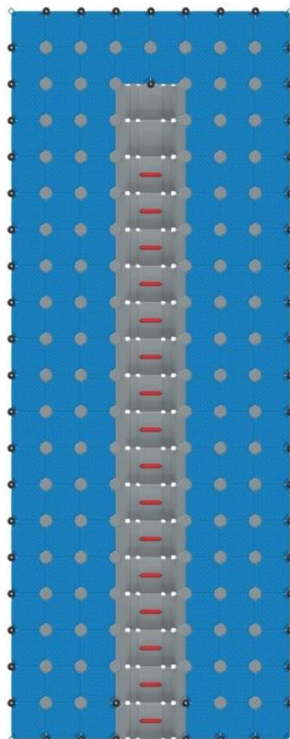

**Boat Slider U-Slide 1000 XL**

Price: **10 670,00 €**

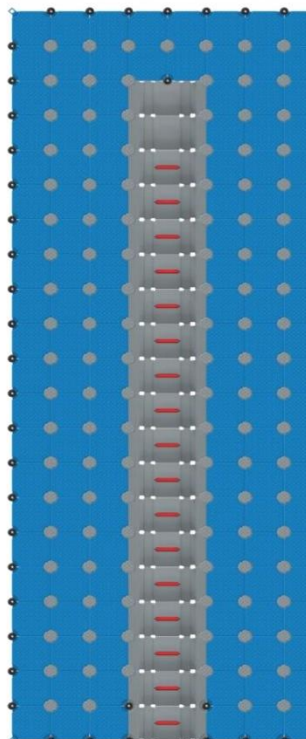

**Boat Slider U-Slide 1050 XL**

Price: **11 210,00 €**

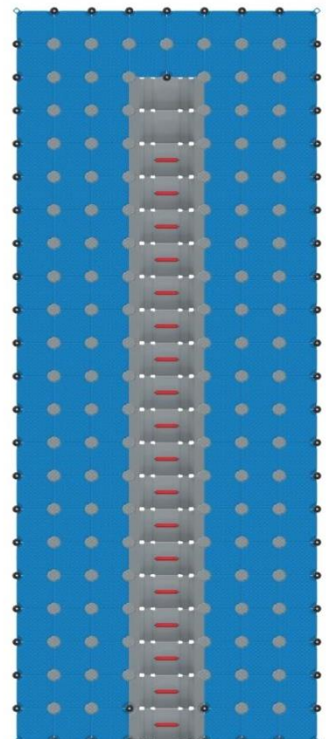

**Boat Slider U-Slide 1100 XL**

Price: **11 750,00 €**

[www.esc.guide/bulldock](http://www.esc.guide/bulldock)

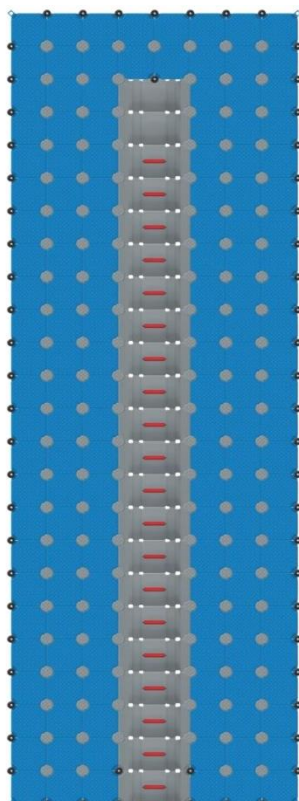

**Boat Slider U-Slide 1150 XL**

Price: **12 290,00 €**

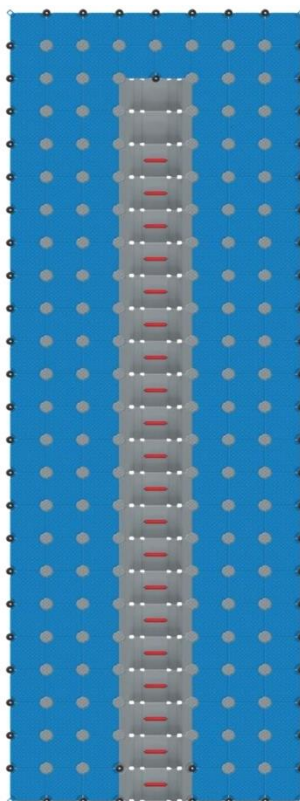

**Boat Slider U-Slide 1200 XL**

Price: **12 830,00 €**

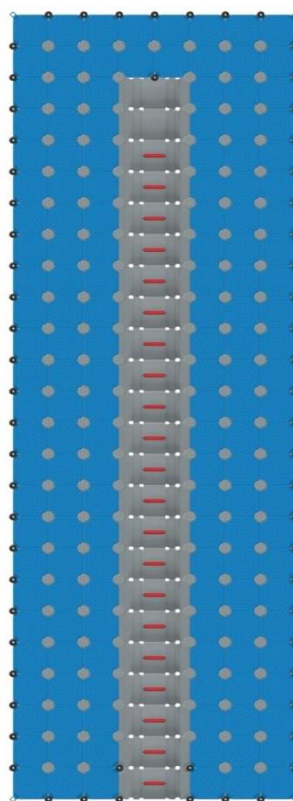

**Boat Slider U-Slide 1250 XL**

Price: **13 370,00 €**

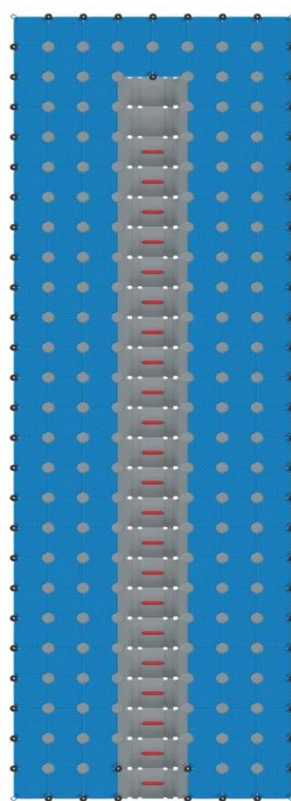

**Boat Slider U-Slide 1300 XL**

Price: **13 910,00 €**

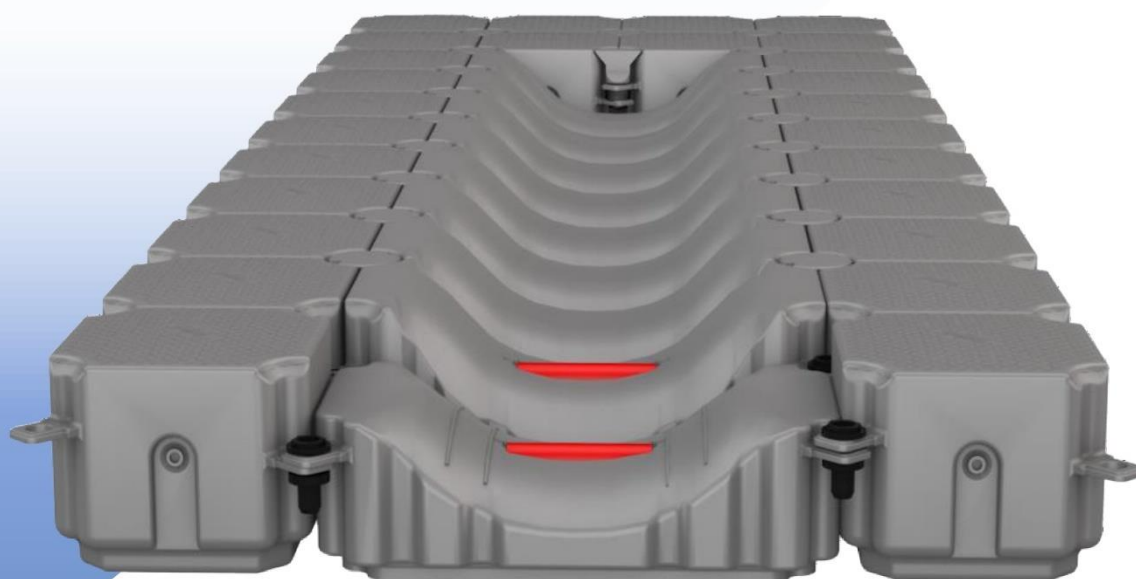

[www.esc.guide/bulldock](http://www.esc.guide/bulldock)



# Pontoons, Docks & Marinas

<https://www.esc.guide/post/floating-docks>

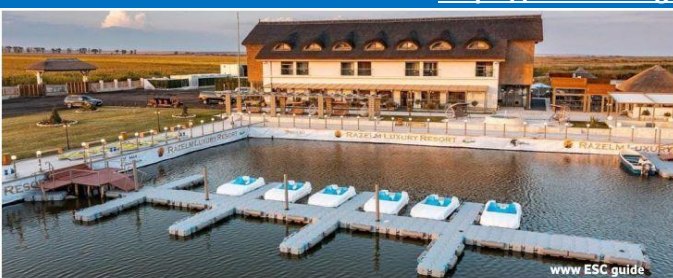

# **BULDOCK**

FLOATING DOCK



## Quality Modular Pontoon Systems

[www.esc.guide/bulldock](http://www.esc.guide/bulldock)

**Beach Sezlongs**

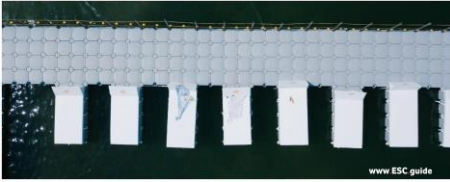

**VIP Sea Entry**



**Dock Everywhere**



**Nautical Clubs**

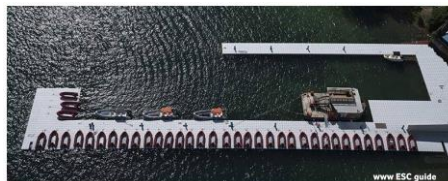



[www.esc.guide/buldock](http://www.esc.guide/buldock)

## Marinas

<https://www.esc.guide/post/buldock-marina>



**PRICELIST**

PRICE	PRODUCT	PAGE
44.00 €	Cube H40	29
41.00 €	Cube H27	29
65.00 €	V-Cube H40	29
61.00 €	V-Cube H27 – Flat	30
96.00 €	V-Cube H40 – Roller	30
92.00 €	V-Cube H27 – Roller	30
92.00 €	V-Cube H25 – Roller	31
96.00 €	V-Cube H35 – Roller	31
180.00 €	U-Slide H40 – Roller	31
165.00 €	U-Slide H40	32
180.00 €	U-Slide H30 – Roller	32
9.80 €	Connecting Pin TFP Model	32
9.80 €	Half Pin	33
2.80 €	Sliding Nut	33
2.60 €	Nut	33
1.50 €	Spacer	34
7.50 €	Lug Connector BG	34
6.90 €	Lug Connector with Ribs	34
65.00 €	Connecting Pin with Top Up Ring	35
65.00 €	Connecting Pin with Stud	35
95.00 €	Inox Cleat	35
85.00 €	Galvanized Cleat	35
75.00 €	Connecting Pin With Inox Cleat – Strong	36
25.00 €	HDPE Cleat	36
70.00 €	Connecting Pin With Solar Navigation Light	36
55.00 €	Connecting Pin With Solar Deck Light	37
55.00 €	Connecting Pin With Solar Deck Light - Blue	37
49.00 €	Single Fender	37
80.00 €	Double Fender	38
900.00 €	Inox Ladder	38
800.00 €	Inox Ladder Flat Steps	38
130.00 €	Single Handrail Bar - Galvanized Steel	39
170.00 €	Single Handrail Bar - Inox Steel	39
50.00 €	Middle HDPE Handrail Bar	39
225.00 €	Handrail 100 cm - Silver/Black	40
245.00 €	Handrail 150 cm - Silver	40
330.00 €	Handrail 200 cm - Silver/Black	40
150.00 €	Handrail Industrial	41
75.00 €	Connecting Pin with Umbrella Holder	42
75.00 €	Fishing Rod Holder	42
65.00 €	Double Layer Connector HD	42
25.00 €	Double Layer Connector	43

<b>170.00 €</b>	Storage Cube	43
<b>169.00 €</b>	Side Roller Set - 1 piece	43
<b>650.00 €</b>	Heavy Duty Side Roller Set	44
<b>38.00 €</b>	Keel Roller RP-5 with Axis	45
<b>45.00 €</b>	Keel Roller RP-212 with Axis	45
<b>850.00 €</b>	Winch post with bow rollers/ no winch 401.4-6	45
<b>900.00 €</b>	Winch post with bow rollers/ no winch 401.6-8	45
<b>950.00 €</b>	Winch post with bow rollers/ no winch 401.8-1	45
<b>200.00 €</b>	Small Handwinch with Strap – Boats 1500 KGS/ 6m	46
<b>300.00 €</b>	Small Handwinch with Strap – Boats 3000 KGS/12m	46
<b>1 390.00 €</b>	Electric Winch NINJA	46
<b>1 820.00 €</b>	Electric Winch WARRIOR	46
<b>69.00 €</b>	Assembling Tool	47
<b>35.00 €</b>	Nut Tool	47
<b>65.00 €</b>	Hexagon Screw Tool	47
<b>65.00 €</b>	Hex Bit Socket Set for Lug Connectors	48
<b>20.00 €</b>	BulDock Grease Lubricant	48
<b>50.00 €</b>	Anchoring Ring	48
<b>75.00 €</b>	Anchoring Pin	49
<b>60.00 €</b>	Double Anchoring Beam	49
<b>110.00 €</b>	Side Mooring Set	49
<b>190.00 €</b>	Helix ECO Anchor Ellipse I	50
<b>270.00 €</b>	Helix ECO Anchor Ellipse II	50
<b>380.00 €</b>	Helix ECO Anchor IIR	50
<b>520.00 €</b>	Helix ECO Anchor Ellipse IIIS	50
<b>620.00 €</b>	Helix ECO Anchor Ellipse IVF	50
<b>25.00 €</b>	Hot Dipped Galvanized Chain - DIN 764 - HDG Ø 14 mm	51
<b>29.00 €</b>	Hot Dipped Galvanized Chain - DIN 764 - HDG Ø 16 mm	51
<b>39.00 €</b>	Hot Dipped Galvanized Chain - DIN 764 - HDG Ø 20 mm	51
<b>5,50 €</b>	Hot Dipped Galvanized Shackle - HDG Ø 16 mm	51
<b>8,90 €</b>	Hot Dipped Galvanized Shackle - HDG Ø 18 mm	51
<b>9,90 €</b>	Hot Dipped Galvanized Shackle - HDG Ø 20 mm	51
<b>15,00 €</b>	Hot Dipped Galvanized Shackle - HDG Ø 22 mm	51
<b>190.00 €</b>	Pile Guiding Cube H40 – Φ160 mm	52
<b>250.00 €</b>	Pile Guiding Cube H40 – Φ250 mm	52
<b>300.00 €</b>	Pile Guiding Cube H40 – Φ315 mm	52
<b>590.00 €</b>	Adjustable Pile Guide – Aluminum Ø 160 mm -230 mm - 10 mm Single Plate	52
<b>750.00 €</b>	Adjustable Pile Guide – Aluminum Ø 160 mm -230 mm - 20 mm Double Plate	52
<b>350.00 €</b>	Adjustable Pile Guide – HDPE Ø 200 mm - 230 mm	52
<b>140.00 €</b>	Pontoon-to-Pontoon Adaptor	53
<b>390.00 €</b>	Mooring Arm Bracket	53
<b>160.00 €</b>	Wall Plate	54
<b>120.00 €</b>	Galvanized Pile Bracket V2	54
<b>220.00 €</b>	Galvanized Pile Bracket V3	54
<b>650.00 €</b>	Wall Bracket Adaptor Set Adjustable	55
<b>95.00 €</b>	Wall Bracket Adaptor Plate – Galvanized – Model V	55

<b>35.00 €</b>	Pipe Galvanized Steel Ø 48mm	55
<b>150.00 €</b>	T-Beam – 250	56
<b>200.00 €</b>	T-Beam – 300	56
<b>250.00 €</b>	T-Beam – 350	56
<b>300.00 €</b>	T-Beam – 400	56
<b>3 500.00 €</b>	Aluminum Gangway with Handrails	57
<b>250.00 €</b>	Pontoon Transition Plate 100	57
<b>350.00 €</b>	Pontoon Transition Plate 150	57
<b>150.00 €</b>	Plate Connecting Adaptor – Pier to Pontoon	57
<b>180.00 €</b>	Plate Connecting Adaptor – Pontoon to Shore	57
<b>1 950.00 €</b>	Air Lifter Set 600	58
<b>2 900.00 €</b>	Air Lifter Set 2000	58

### Cube H40



Price:

**44,00 €**

Material / Composition: High-density Polyethylene (HDPE)  
Surface: Anti-Slip  
Dimensions: 50 x 50 x 40 cm (Length / Width / Height)  
Weight: 6.8 kg  
Capacity: 92 kg per cube or 368 kg per m<sup>2</sup>

Grey

003622S16

Light Blue

003625S16

Beige

003628S16

Orange

003750S16

\*Any colour per customers wishes

### Cube H27



Price:

**41,00 €**

Material / Composition: High-density Polyethylene (HDPE)  
Surface: Anti-Slip  
Dimensions: 50 x 50 x 27 cm (Length / Width / Height)  
Weight: 5.5 kg  
Capacity: 62 kg per cube or 248 kg per m<sup>2</sup>

Grey

003729S16

Light Blue

003730S16

Beige

003731S16

Orange

003778S16

\*Any colour per customers wishes

### V-Cube H40



Price:

**65,00 €**

Material / Composition: High-density Polyethylene (HDPE)  
Surface: Anti-Slip  
Dimensions: 50 x 50 x 40 cm (Length / Width / Height)  
Weight: 8.0 kg  
Capacity: 80 kg per cube or 320 kg per m<sup>2</sup>

Grey

003743S16

### V-Cube H27 Flat



Price:

**61,00 €**

Material / Composition: High-density Polyethylene (HDPE)  
Surface: Anti-Slip  
Dimensions: 50 x 50 x 27 cm (Length / Width / Height)  
Weight: 7.5 kg  
Capacity: 50 kg per cube or 200 kg per m<sup>2</sup>

Grey

003737S16

### V-Cube H40 – Roller



Price:

**96,00 €**

Material / Composition: High-density Polyethylene (HDPE)  
Surface: Anti-Slip  
Dimensions: 50 x 50 x 40 cm (Length / Width / Height)  
Weight: 8.5 kg  
Capacity: 80 kg per cube or 320 kg per m<sup>2</sup>

Grey

003740S16

### V-Cube H27 – Roller



Price:

**92,00 €**

Material / Composition: High-density Polyethylene (HDPE)  
Surface: Anti-Slip  
Dimensions: 50 x 50 x 27 cm (Length / Width / Height)  
Weight: 8.0 kg  
Capacity: 50 kg per cube or 200 kg per m<sup>2</sup>

Grey

003734S16

### V-Cube H25 – Roller



Price:

**92,00 €**

Material / Composition: High-density Polyethylene (HDPE)  
Surface: Anti-Slip  
Dimensions: 50 x 50 x 25 cm (Length / Width / Height)  
Weight: 8.0 kg  
Capacity: 50 kg per cube or 200 kg per m<sup>2</sup>

Grey

003952S16

### V-Cube H35 – Roller



Price:

**96,00 €**

Material / Composition: High-density Polyethylene (HDPE)  
Surface: Anti-Slip  
Dimensions: 50 x 50 x 35 cm (Length / Width / Height)  
Weight: 8.0 kg  
Capacity: 50 kg per cube or 200 kg per m<sup>2</sup>

Grey

003989S16

### U-Slide H40 – Roller



Price:

**180,00 €**

Material / Composition: High-density Polyethylene (HDPE)  
Surface: Anti-Slip  
Dimensions: 100 x 50 x 40 cm (Length / Width / Height)  
Weight: 12.0 kg  
Capacity: 150 kg per U-slide or 300 kg per m<sup>2</sup>

Grey

2021BG001

## U-Slide H40

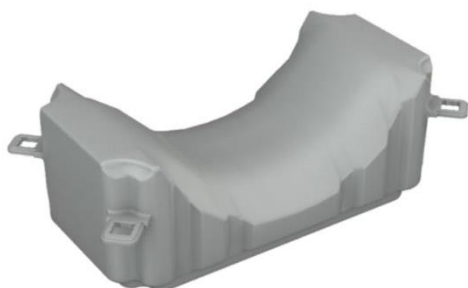

Price:

**165,00 €**

Material / Composition: High-density Polyethylene (HDPE)  
Surface: Anti-Slip  
Dimensions: 100 x 50 x 40 cm (Length / Width / Height)  
Weight: 10.5 kg  
Capacity: 150 kg per U-slide or 300 kg per m<sup>2</sup>

Grey

2021BG002

## U-Slide H30 - Roller



Price:

**180,00 €**

Material / Composition: High-density Polyethylene (HDPE)  
Surface: Anti-Slip  
Dimensions: 100 x 50 x 30 cm (Length / Width / Height)  
Weight: 12.0 kg  
Capacity: 100 kg per U-slide or 200 kg per m<sup>2</sup>

Grey

2021BG003

## Connecting Pin TFP



Price:

**9,80 €**

Material / Composition: High-density Polyethylene (HDPE)  
Surface: Anti-Slip  
Dimensions: 25.5 x 18.0 cm (Height / Ø)  
Weight: 0.480 kg

Grey

003850S16

Light Blue

003961S16

Beige

003962S16

Orange

003963S16

**\*Connecting Pin Standard**

\*Any colour per customers wishes



Grey

003623S16



## Half Pin



Price:

**9,80 €**

Material / Composition: High-density Polyethylene (HDPE)  
Surface: Anti-Slip  
Dimensions: 27.5 x 8 cm (Height / Ø)  
Weight: 0.330 kg

Grey

003624S16

Light Blue

003627S16

Beige

003630S16

Orange

003783S16

\*Any colour per customers wishes

## Sliding Nut



Price:

**2,80 €**

Material / Composition: High-density Polyethylene (HDPE)  
Dimensions: 5 x 9.5 cm (Length / Ø)  
Weight: 0.069 kg

Black

003728T16



## Nut

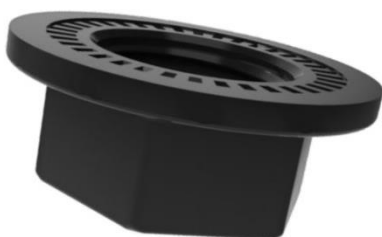

Price:

**2,60 €**

Material / Composition: High-density Polyethylene (HDPE)  
Dimensions: 3.5 x 8.5 cm (Length / Ø)  
Weight: 0.060 kg

Black

003650T16

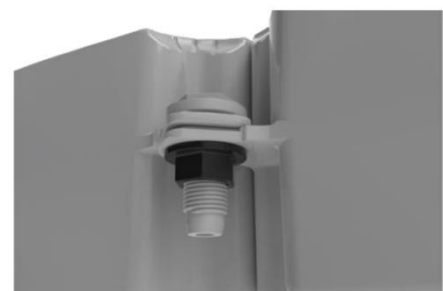

## Spacer



Price:

**1,50 €**

Material / Composition: High-density Polyethylene (HDPE)  
Dimensions: 1.5 x 9 cm (Length / Ø)  
Weight: 0.038 kg

Black

003732T16

## Lug Connector BG

**NEW**

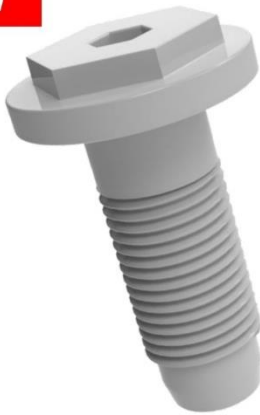

Price:

**7,50 €**

Material / Composition: High-density Polyethylene (HDPE)  
Dimensions: 13.5 x 9 cm (Height / Ø)  
Weight: 0.225 kg

Grey

2023BG005



## Lug Connector with Rib



Price:

**6,90 €**

Material / Composition: High-density Polyethylene (HDPE)  
Dimensions: 13.5 x 9 cm (Height / Ø)  
Weight: 0.225 kg

Black

003752T16

## Connecting Pin with Top Up Ring



Price:

**65,00 €**

Material / Composition: High-density Polyethylene (HDPE) & INOX Steel

Surface: Anti-Slip

Dimensions: 30 x 18 cm (Height / Ø)

Weight: 2.500 kg

Black

2019BG002

## Connecting Pin with Stud



Price:

**65,00 €**

Material / Composition: High-density Polyethylene (HDPE) & INOX Steel

Surface: Anti-Slip

Dimensions: 34 x 18 cm (Height / Ø)

Weight: 2.00 kg

Grey

2020BG014

## Cleat



INOX CLEAT

**95,00 €**

GALVANIZED CLEAT

**85,00 €**

Material / Composition: INOX Steel / Hot Galvanized Steel

Dimensions: 20 x 37.5 cm (Width / Height)

Weight: 2.00 kg

Silver

2020BG001

www.esc.guide/bulldock

## Connecting Pin With Inox Cleat – Strong



Price:

**75,00 €**

Material / Composition: High-density Polyethylene (HDPE) & INOX Steel

Surface: Anti-Slip

Dimensions: 30 x 18 cm (Height / Ø)

Weight: 3.00 kg

Black

2018BG006

## HDPE Cleat



Price:

**25,00 €**

Material / Composition: High-density Polyethylene (HDPE)

Dimensions: 25 x 13 cm (Width / Height)

Weight: 0.380 kg

Grey

2023BG008



## Connecting Pin with Solar Navigation Light



Price:

**70,00 €**

Material / Composition: High-density Polyethylene (HDPE)

Dimensions: 38.5 x 18 cm (Height / Ø)

Weight: 0.715 kg

Grey

2021BG019

Light Blue

2021BG020

Beige

2021BG021

Orange

2021BG022

\*Changing LED Illumination colour: White, Green, Blue, Orange, Yellow, Red



**Connecting Pin with Solar Deck Light**



Price:	<b>55,00 €</b>
--------	----------------

Material / Composition: High-density Polyethylene (HDPE)  
 Dimensions: 28 x 18 cm (Height / Ø)  
 Weight: 0.700 kg

Grey	Light Blue	Beige	Orange
2022BG001	2022BG002	2022BG003	2022BG004

\*LED Illumination colour: White 

**Connecting Pin with Solar Deck Light - Blue**



Price:	<b>55,00 €</b>
--------	----------------

Material / Composition: High-density Polyethylene (HDPE)  
 Dimensions: 28 x 18 cm (Height / Ø)  
 Weight: 0.700 kg

Grey	Light Blue	Beige	Orange
2022BG013	2022BG014	2022BG015	2022BG016

\*LED Illumination colour: Blue 

**Single Fender**



Price:	<b>49,00 €</b>
--------	----------------

Material / Composition: High-density Polyethylene (HDPE)  
 Surface: Anti-Slip  
 Dimensions: 50 x 25 x 35 cm (Length / Width / Height)  
 Weight: 3.500 kg

Grey
2020BG003



www.esc.guide/bulldock

## Double Fender



Price:

**80,00 €**

Material / Composition: High-density Polyethylene (HDPE)  
Surface: Anti-Slip  
Dimensions: 100 x 20 x 27 cm (Length / Width / Height)  
Weight: 4.600 kg

Grey  
2020BG004



## INOX Ladder



Price:

**900,00 €**

Material / Composition: INOX Steel  
Dimensions: 83 x 183 cm (Width / Height)  
Weight: 18.00 kg

Silver  
2018BG011

**\*The Price includes 4 x Connecting Pin with Stud for the Ladder installation.**



**4 x Connecting Pin with Stud**

## INOX Ladder Flat Steps



Price:

**800,00 €**

Material / Composition: INOX Steel  
Dimensions: 83 x 183 cm (Width / Height)  
Weight: 18.00 kg

Silver  
2023BG006

**\*The Price includes 4 x Connecting Pin with Stud for the Ladder installation.**



**4 x Connecting Pin with Stud**

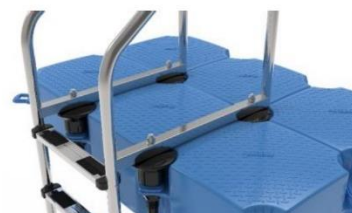

## Single Handrail Bar



Galvanized Steel	<b>130,00 €</b>
INOX Steel	<b>170,00 €</b>

Material / Composition: Galvanized Steel / INOX Steel  
 Dimensions: 4,5 x 110 cm (Width / Height)  
 Weight: 3.500 kg

Silver/Black	Silver
2018BG012	2018BG012.1

## Middle HDPE Handrail Bar



Price:	<b>50,00 €</b>
--------	----------------

Material / Composition: High-density Polyethylene (HDPE)  
 Dimensions: 11 x 11 x 110 cm (Length / Height)  
 Weight:

White
2022BG017

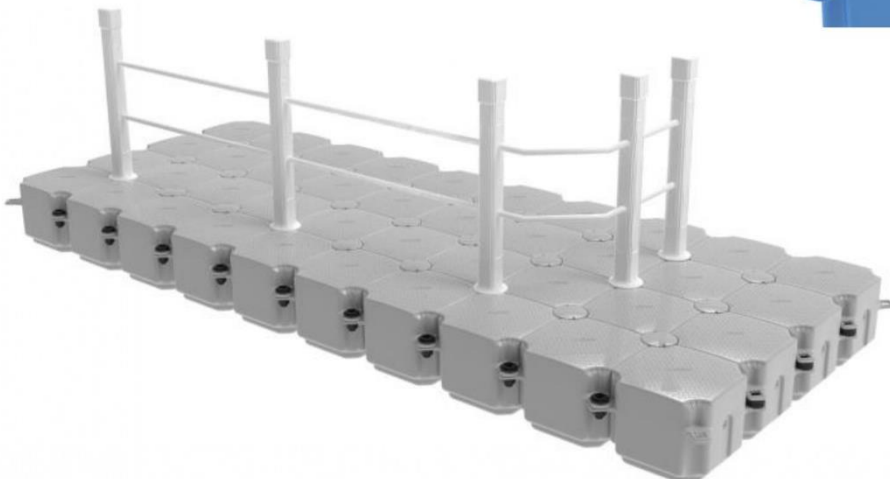

## Handrail

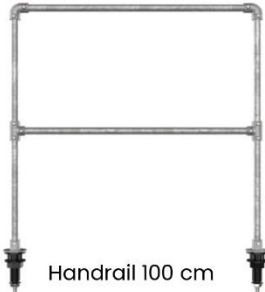

Handrail 100 cm

**225,00 €**

Handrail 150 cm

**245,00 €**

Handrail 200 cm

**330,00 €**

Material / Composition: Galvanized Steel

Dimensions: 100/150/200 x 110 cm (Length / Height)

Weight: -- kg



Silver

2023BG001, 100 cm

2023BG002, 150 cm

2023BG003, 200 cm

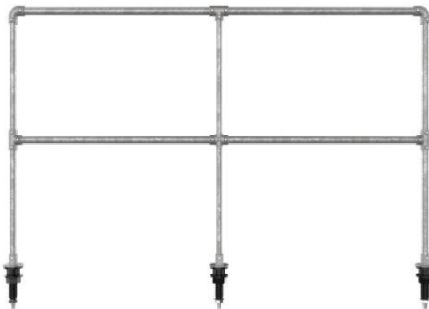

## Installation Options

Available options for the installation of the Handrail 100 cm, 150 cm, upon project requirements – middle or external installation options.

**⚠ Please, indicate in your quote inquiry the desired installation option for the Handrail 100,150 or 200 cm.**



**1 - External Installation**



**2 - Middle Installation**



www.esc.guide/bulldock

## Handrail Industrial



Price:

**150,00 €**

**Price is per linear meter.**

Material / Composition: Galvanized Steel  
Dimensions: Upon Project requirements  
Weight: -- kg

Silver

2023BG004



## Installation Options

Available options for the installation of the Handrail Industrial, upon project requirements – middle or external installation options.

**⚠ Please, indicate in your quote inquiry the desired installation option for the Handrail 100,150 or 200 cm.**



**1 - External Installation**



**2 - Middle Installation**

## Connecting Pin with Umbrella Holder



Price:

**75,00 €**

Material / Composition: High-density Polyethylene (HDPE) & INOX Steel

Surface: Anti-Slip

Dimensions: 59 x 18 cm (Height / Ø)

Weight: 2.800 kg

Grey

2020BG015

## Fishing Rod Holder



Price:

**75,00 €**

Material / Composition: High-density Polyethylene (HDPE)

Surface: Anti-Slip

Dimensions: 28 x 18 cm (Height / Ø)

Weight: 0.700 kg

Grey

2022BG018

## Double Layer Connector HD



Price:

**65,00 €**

Material / Composition: High-density Polyethylene (HDPE)

Dimensions: 57 x 5 cm (Height / Ø)

Weight: 1.300 kg

White

2019BG006

### Double Layer Connector



Price:

**25,00 €**

Material / Composition: High-density Polyethylene (HDPE)  
Dimensions: 57 x 5 cm (Height / Ø)  
Weight: 1.300 kg

Grey

2023BG007



### Storage Cube



Price:

**170,00 €**

Material / Composition: High-density Polyethylene (HDPE)  
Surface: Anti-Slip  
Dimensions: 50 x 50 x 40 cm (Length / Width / Height)  
Weight: 7.5 kg  
Capacity: 92 kg per cube or 368 kg per m<sup>2</sup>  
Hatch Dimensions: 37.5 x 37.5 cm (Length / Width)

Grey

2021BG015

Light Blue

2021BG016

Beige

2021BG017

Orange

2021BG018

\*Any colour per customers wishes

### Side Roller Set – 1 piece



Price:

**169,00 €**

Material / Composition: INOX Steel / Polyurethane  
Dimensions: 44/55 x 18 cm (Height / Ø)  
Weight: 4.150 kg

Red

2021BG004



[www.esc.guide/buldock](http://www.esc.guide/buldock)

## Heavy Duty Side Roller Set

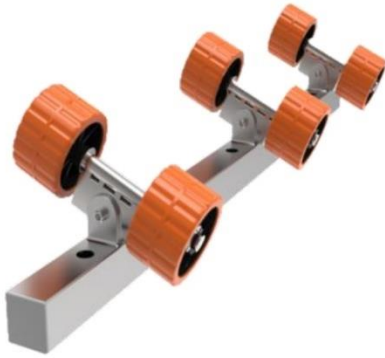

Price:

**650,00 €**

Material / Composition:

INOX Steel / Polyurethane

Dimensions:

**\*Designed for heavy boats**

130.5 cm x 27.5 cm x 19.0 cm

(Length / Width / Height)

Weight:

10.00 kg

Red

2023BG012



The Price includes 3 x Connecting Pin with

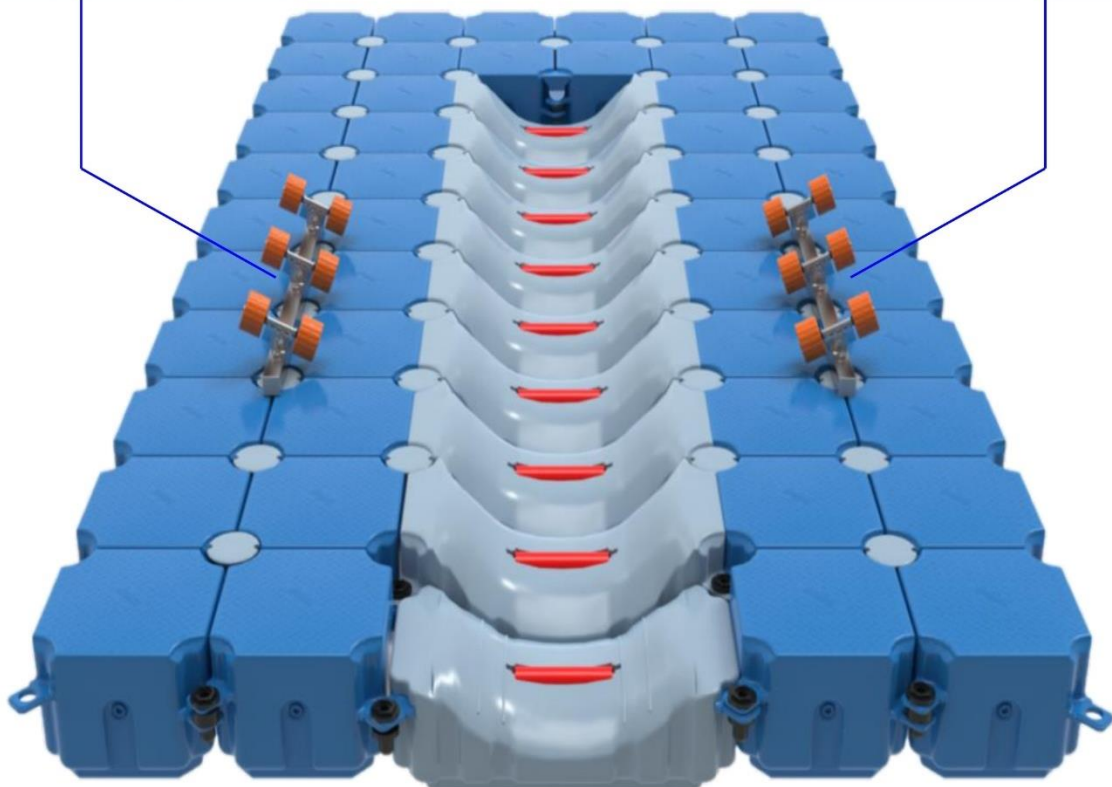

### Keel Roller RP-5 with Axis



Price:

**38,00 €**

Material / Composition: Polyurethane, Steel AISI 316

Dimensions: 12 x 7 cm (Length / Ø)

Weight: 0.590 kg

Red

2018BG010

**\*The Price includes 1 x INOX axis for the Keel Roller**



1 x INOX Axis

### Keel Roller RP-212 with Axis



Price:

**45,00 €**

Material / Composition: Polyurethane, Steel AISI 316

Dimensions: 29.5 x 6 cm (Length / Ø)

Weight: 1.420 kg

Red

2021BG005

**\*The Price includes 1 x INOX axis for the Keel Roller**



1 x INOX Axis

### Winch post with Bow Rollers/ no winch



Model №:

Price:

401.4-6

**850,00 €**

401.6-8

**900,00 €**

401.8-1

**950,00 €**

Material / Composition: INOX Steel

Dimensions: 680-800 x 102 x 600-800 mm  
(Length / Width/ Height)

Weight: 15.00 kg

Silver

401.4-6

Silver

401.6-8

Silver

401.8-1

## Small Hand Winch with Strap



Model №:	Price:
Boats 1500 kgs / 6m	<b>200,00 €</b>
Boats 3000 kgs / 12m	<b>300,00 €</b>
Silver	Silver
103231	1032313

## Electric Winch



Model №:	Price:
<b>NINJA</b>	<b>1 390,00 €</b>
<b>WARRIOR</b>	<b>1 820,00 €</b>

### Description:

Winch is equipped with a 70% stronger Amortek winch rope instead of a traditional steel cable.

- Small winch rope assembled specially.
- Stainless steel winch adapter plate for attaching the electric winch to the winch pole.
- Stainless steel Battery box holder for a secure attachment to the trailer chassis
- 80 Amp. – model №: 401513/ 100 Amp. – model №: 401520 High quality Semi-traction battery for long-term discharge.
- Fully automatic battery charger which, in addition to charging, also keeps the battery in top condition automatically.
- Main switch with red main switch key
- Remote control wired for both models and wired and wireless for **model №: 401520**.

**⚡ The specified model is indicative and can be replaced with a similar according to the parameters model, available at the market.**

## Assembling Tool



Price:

**69,00 €**

Material / Composition: INOX Steel  
Dimensions: 55 x 100 cm (Width/ Height)  
Weight: 4.150 kg

Silver

2018BG013

## Nut Tool



Price:

**35,00 €**

Material / Composition: Aluminium  
Dimensions: 36 x 9 cm (Length / Width)  
Weight: 0.200 kg

Silver

2019BG013

## Hexagon Screw Tool



Price:

**65,00 €**

Material / Composition: INOX Steel  
Dimensions: 40 x 65 cm (Width/ Height)  
Weight: 2.00 kg

Silver

2020BG017

www.esc.guide/bulldock

## Hex Bit Socket Set for Lug Connectors



Price:

**65,00 €**

Material / Composition: Chrome, Molybdenum, Alloy, Steel

Dimensions: Length: 6.5 cm (Width/Height)  
Weight: 0.240 kg

Black

2023BG013



## BulDock Grease Lubricant



Price:

**20,00 €**

Material / Composition: Food Grade Silicone Grease  
Weight: 0.200 g

White

2022BG019

## Anchoring Ring



Price:

**50,00 €**

Material / Composition: High-density Polyethylene (HDPE) & INOX Steel

Dimensions: 31 x 9 cm (Length / Ø)  
Weight: 1.230 kg

Black

2019BG008



## Anchoring Pin



Price:

**75,00 €**

Material / Composition: High-density Polyethylene (HDPE) & INOX Steel

Surface: Anti-Slip

Dimensions: 31 x 9 cm (Length / Ø)

Weight: 1.230 kg

Black

2018BG004

## Double Anchoring Beam



Price:

**60,00 €**

Material / Composition: Galvanized Steel

Dimensions: 60 x 4 x 12 cm (Length / Width / Height)

Weight: 2.00 kg

Silver

2022BG005



## Side Mooring Set



Price:

**110,00 €**

Material / Composition: Galvanized Steel

Dimensions: 60 x 12 cm (Length / Height)

Weight: 4.00 kg

Silver

2022BG006



**Helix ECO Anchors**

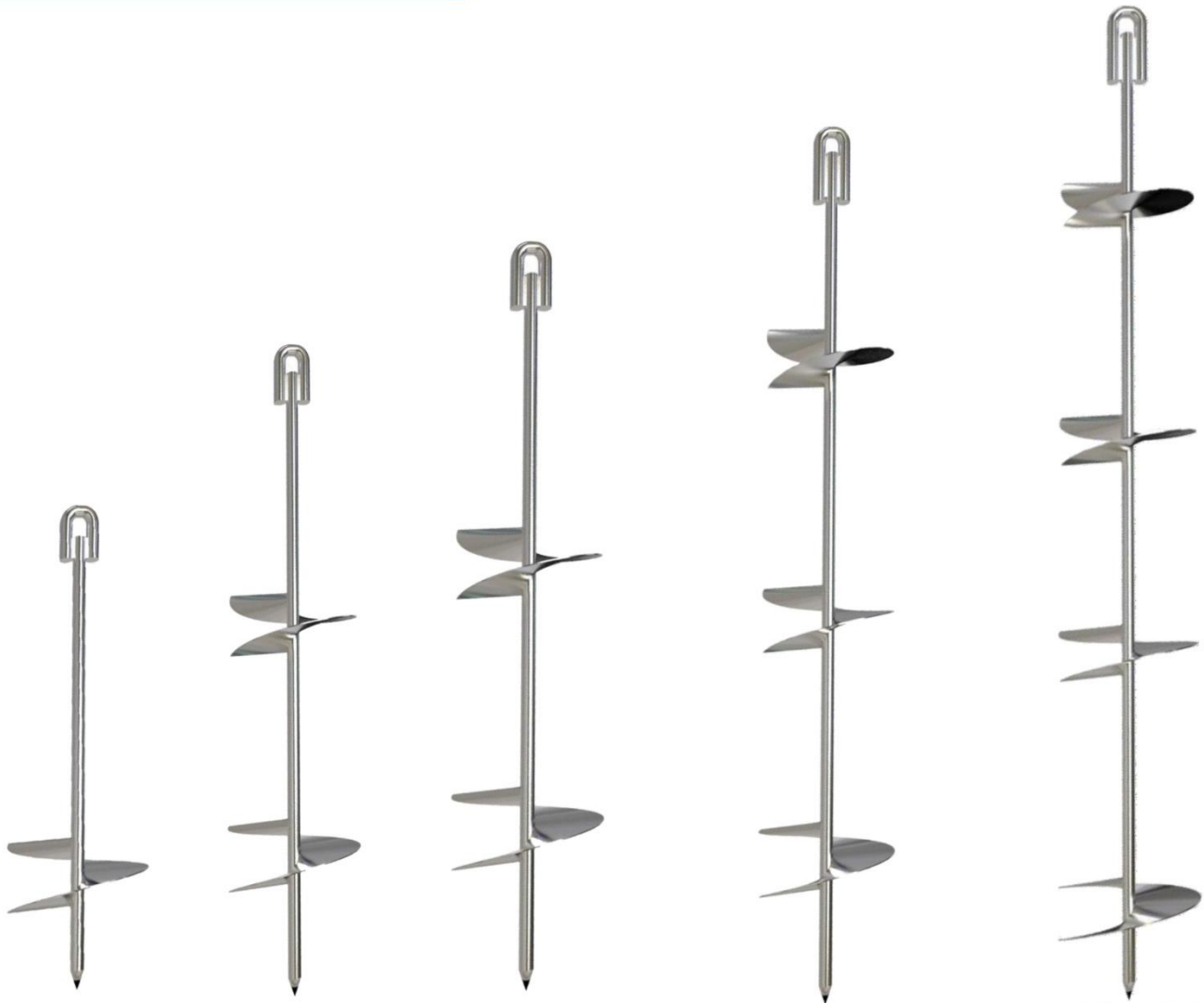

**Ellipse I**

**Ellipse II**

**Helix II R**

**Ellipse IIIS**

**Ellipse IVF**

Model No:	Height / Ø Disk / Ø Rod	Weight:	Price:
<b>Ellipse I</b>	100 cm x 25cm x 2.5 cm	5.5 kg.	<b>190,00 €</b>
<b>Ellipse II</b>	150 cm x 25 cm x 2.5 cm	8.5 kg.	<b>270,00 €</b>
<b>Helix II R</b>	200 cm x 30 cm x 2.5 cm	19.0 kg.	<b>380,00 €</b>
<b>Ellipse IIIS</b>	200 cm x 30 cm x 3.0 cm	24.0 kg.	<b>520,00 €</b>
<b>Ellipse IVF</b>	300 cm x 30/40 cm x 3.0 cm	28.0 kg.	<b>620,00 €</b>

Tensile Strength Certificate	Ellipse I	Ellipse II	Ellipse IIIS	Ellipse IVF
<b>Minimum holding certified by VERITAS - soft soil</b>	<b>0.8 t</b>	<b>1.0 t</b>	<b>2.3 t</b>	<b>4.0 t</b>
<b>Equivalent concrete block - soft soil</b>	<b>1.1 t</b>	<b>1.7 t</b>	<b>3.3 t</b>	<b>5.7 t</b>
<b>Minimum holding certified by VERITAS - compact soil</b>	<b>1.3 t</b>	<b>2.0 t</b>	<b>4.2 t</b>	<b>5.3 t</b>
<b>Equivalent concrete block - compact soil</b>	<b>1.8 t</b>	<b>2.9 t</b>	<b>6.0 t</b>	<b>7.7 t</b>

## Hot Dipped Galvanized Chain - DIN 764



Product Code:	Model:	Price:
<b>2022BG027</b>	HDG Ø 14 mm	<b>25,00 €</b>
<b>2022BG028</b>	HDG Ø 16 mm	<b>29,00 €</b>
<b>2022BG029</b>	HDG Ø 20 mm	<b>39,00 €</b>

Material / Composition: Hot Dipped Galvanized Steel  
Standard: DIN 764 / Mooring Chain

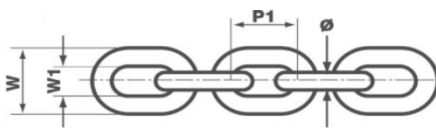

Ø mm	P1 mm	W1 mm	BLL <sup>1</sup>	Weight kg/m
<b>14 mm</b>	<b>49 mm</b>	<b>20 mm</b>	<b>98</b>	<b>4.10 kg</b>
<b>16 mm</b>	<b>56 mm</b>	<b>22 mm</b>	<b>128</b>	<b>5.40 kg</b>
<b>20 mm</b>	<b>70 mm</b>	<b>27 mm</b>	<b>200</b>	<b>8.50 kg</b>

**BLL = Breaking Load Limit**

## Hot Dipped Galvanized Shackle



Product Code:	Model:	Price:
<b>2022BG030</b>	HDG Ø 16 mm	<b>5,50 €</b>
<b>2022BG031</b>	HDG Ø 18 mm	<b>8,90 €</b>
<b>2022BG032</b>	HDG Ø 20 mm	<b>9,90 €</b>
<b>2022BG033</b>	HDG Ø 22 mm	<b>15,00 €</b>

Material / Composition: Hot Dipped Galvanized Steel  
Standard: Stamped CEE, Diameter, W.L.L. brand  
Safety Ratio: 4:1

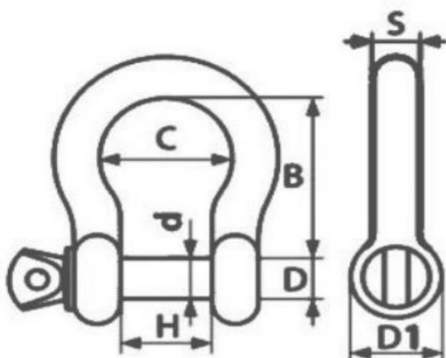

Ø mm	B mm	H mm	C mm	kg / unit
<b>16 mm</b>	<b>64 mm</b>	<b>32 mm</b>	<b>48 mm</b>	<b>0.47 kg</b>
<b>18 mm</b>	<b>71 mm</b>	<b>36 mm</b>	<b>54 mm</b>	<b>0.70 kg</b>
<b>20 mm</b>	<b>80 mm</b>	<b>38 mm</b>	<b>60 mm</b>	<b>0.79 kg</b>
<b>22 mm</b>	<b>85 mm</b>	<b>44 mm</b>	<b>66 mm</b>	<b>1.33 kg</b>

## Pile Guiding Cube H40



Dimensions Ø	Price:
Φ160 mm	<b>190,00 €</b>
Φ250 mm	<b>250,00 €</b>
Φ315 mm	<b>300,00 €</b>

Material / Composition: High-density Polyethylene (HDPE)  
 Surface: Anti-Slip  
 Dimensions: 50 x 50 x 40 cm (Length / Width / Height)  
 Weight: 8.00 kg  
 Capacity: 90 kg per cube or 368 kg per m<sup>2</sup>

Grey	Light Blue	Beige	Orange
2018BG001	2018BG002	2018BG003	2018BG004

\*Any colour per customers wishes

## Adjustable Pile Guide – Aluminum Ø 160 mm -230 mm

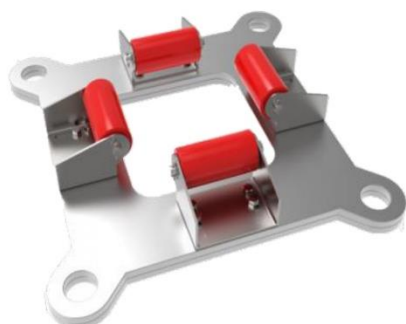

Silver

10 mm 2023BG009  
20 mm 2023BG010

Dimensions:	Price:
10 mm Single Plate	<b>590,00 €</b>
20 mm Double Plate	<b>750,00 €</b>

Material / Composition: Aluminium  
 Dimensions: 50.5 x 50.5 cm (Length / Width)  
 Thickness: 10 mm / 20 mm  
 Weight: 11.50 kg / 17.00 kg  
 Adjustable Diameter: Ø 160 mm - Ø 230 mm



## Adjustable Pile Guide – HDPE Ø 200 mm -230 mm



Price:	<b>350,00 €</b>
--------	-----------------

Material / Composition: High-density Polyethylene (HDPE)  
 Dimensions: 50.5 x 50.5 cm (Length / Width)  
 Thickness: 80 mm  
 Weight: 6.80 kg  
 Adjustable Diameter: Ø 200 mm - Ø 230 mm

Grey

2023BG011

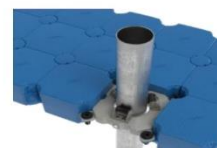

## Pontoon-to-Pontoon Adaptor



Price:

**140,00 €**

Material / Composition: Hot Dipped Galvanized Steel

Silver

2019BG003

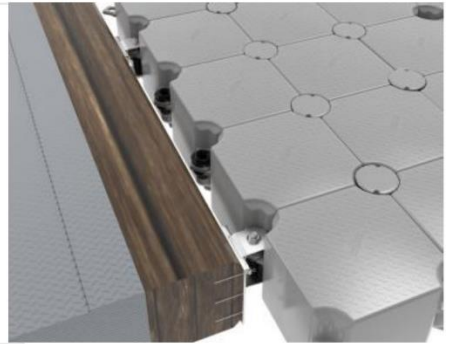
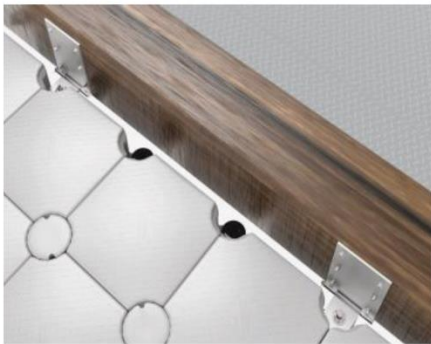

## Mooring Arm Bracket



Price:

**390,00 €**

Material / Composition: Hot Dipped Galvanized Steel

Dimensions: 112 x 72 cm (Length / Height)

Weight: 17.500 kg

Silver

2019BG018

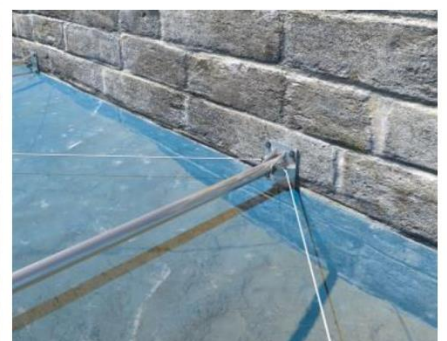

## Wall Plate



Price:

**160,00 €**

Material / Composition: Hot Dipped Galvanized Steel

Dimensions:

Weight:

Silver

2019BG019

## Galvanized Pile Bracket V2



Price:

**120,00 €**

Material / Composition: Galvanized Steel

Dimensions: 60 x 26 cm (Length / Width)

Weight: 3.00 kg

Silver

2021BG006

## Galvanized Pile Bracket V3



Price:

**220,00 €**

Material / Composition: Galvanized Steel

Dimensions: 112 x 30 cm (Length / Width)

Weight: 10.00 kg

Silver

2019BG022

### Wall Bracket Adaptor Set Adjustable



Price:

**650,00 €**

Material / Composition: Galvanized Steel  
Dimensions:  On Request  
Pipe Diameter: 100 mm

Silver

2019BG024

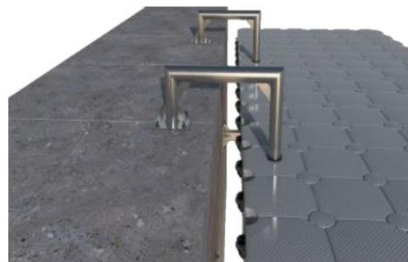

### Wall Bracket Adaptor Plate - Galvanized - Model V



Price:

**95,00 €**

Material / Composition: Galvanized Steel  
Dimensions: 20 x 20 x 17 cm (Length/Width/ Height)  
Weight: 4.4 kg

Silver

2022BG007

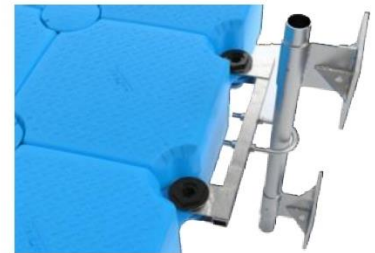

### Pipe Galvanized Steel Ø 48 mm



Price:

**35,00 €**

Material / Composition: Galvanized Steel  
Dimensions: 100 x 0.32 cm (Length / Width)  
Pipe Diameter: 48 mm

Silver

2022BG008



**T - Beam**



Length:	Price:
T-Beam 250 cm	<b>150,00 €</b>
T-Beam 300 cm	<b>200,00 €</b>
T-Beam 350 cm	<b>250,00 €</b>
T-Beam 400 cm	<b>300,00 €</b>

Material / Composition: Galvanized Steel

Silver 250 cm	Silver 300 cm	Silver 350 cm	Silver 400 cm
2022BG009	2022BG010	2022BG011	2022BG012

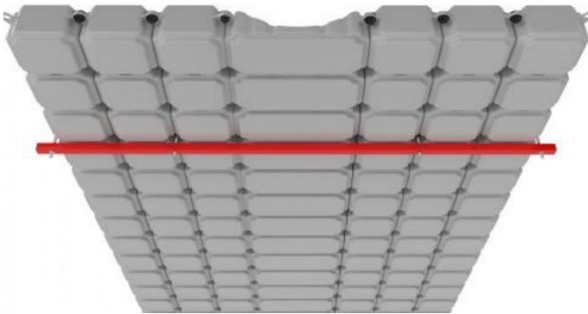

Specially designed for oversized and heavy boats more than 1000 kg. BulDock advise is customers to include one T-Beam in appropriate dimensions to the Boat Slider system to achieve bigger buoyancy and stability. For heavier boats, need to install two T-Beams to the Boat Slider. **⚠️ For maximum efficiency of the T-Beam, we recommend the installation of the T-Beam through Anchoring Pins.**

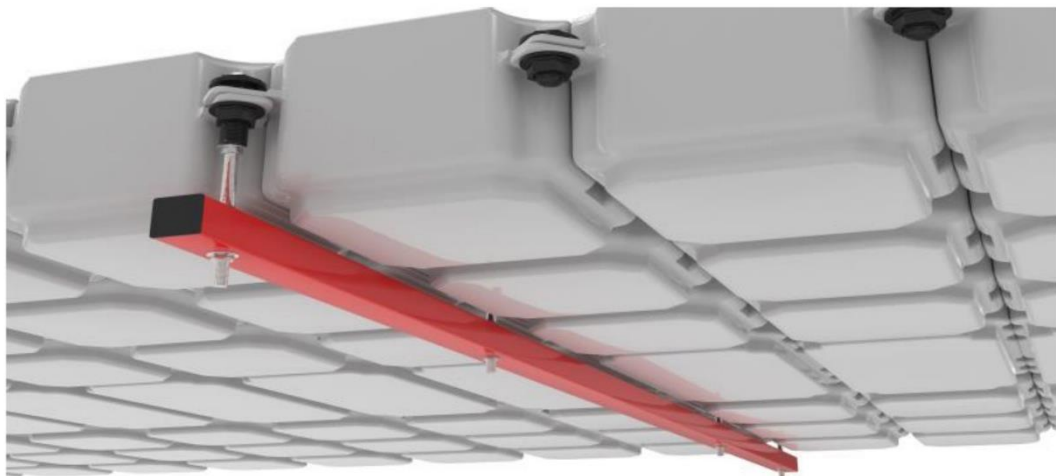



## Aluminum Gangway with Handrails



Price:

**3 500,00 €**

Material / Composition: Aluminium  
Dimensions: 100 cm x 300 cm (Width/Length)

 Various dimensions are available upon request.

Silver

2022BG020

## Pontoon Transition Plate

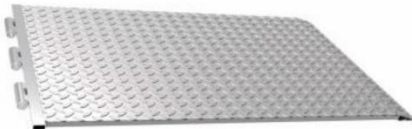

Dimensions Ø

Price:

**100 cm**

**250,00 €**

**150 cm**

**350,00 €**

Material / Composition: Aluminium  
Dimensions: 100 cm x 100 cm (Width/Length)  
100 cm x 150 cm (Width/Length)

Silver

2022BG021

Silver

2022BG022

## Plate Connecting Adaptor - Pier to Pontoon



Price:

**150,00 €**

Material / Composition: Aluminium  
Dimensions: 100 x 13 x 10 cm (Length/ Width/Height)  
Weight: 2.600 kg

Silver

2022BG023

## Plate Connecting Adaptor - Pontoon to Shore



Price:

**180,00 €**

Material / Composition: Aluminum  
Dimensions: 110 x 14 x 12 cm (Length/ Width/Height)  
Weight: 7.400 kg

Silver

2022BG024

**Air Lifter Set**



Model:	Price:
Air Lifter Set <b>600</b>	<b>1 950,00 €</b>
Air Lifter Set <b>2 000</b>	<b>2 900,00 €</b>

**Air Lifter Set include:**

- Floater **600 L** or **2000 L**
- SUPER SILENT Compressor with electronic engine control
- Hoses, valves, accessories
- Fixing accessories

**Air Compressor Specifications:**

- Voltage: 230 V, 50 Hz.
-  **Please contact us for different voltage requirements.**
- Power: 1100 kW with 2 engines with metal tips, each 550 W.
- Noise Level: 65 dB
- Maximum Pressure: 8 bar
- Flow Rate: 240 l/min.
- Tank Volume: 50 l.
- Dimension 600 L: 74 x 216 x h 51 cm;
- Dimension 2000 L: 110 x 260 x h 90 cm
- Weight 600L: 40 kg; 2000L: 80 kg

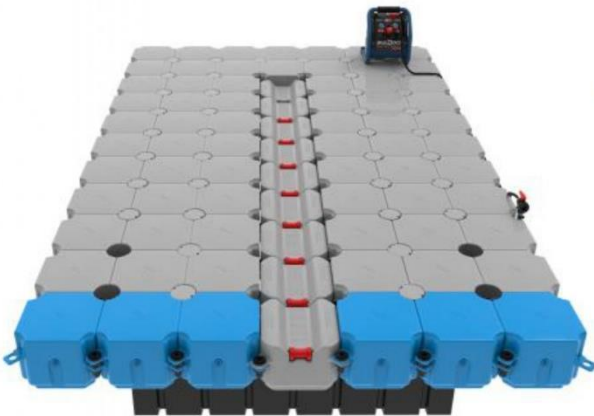

**Boat Slider V-Slide Platform Installation**

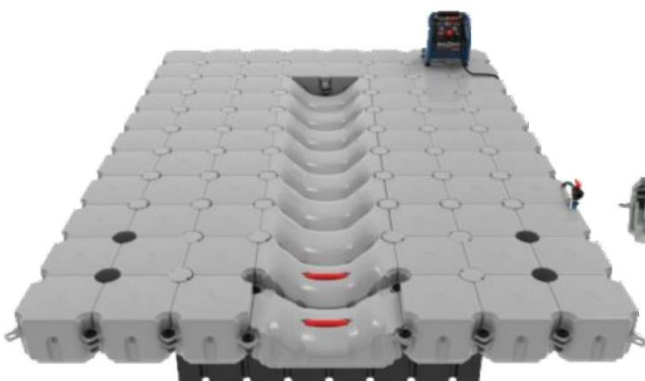

**Boat Slider U-Slide Platform Installation**

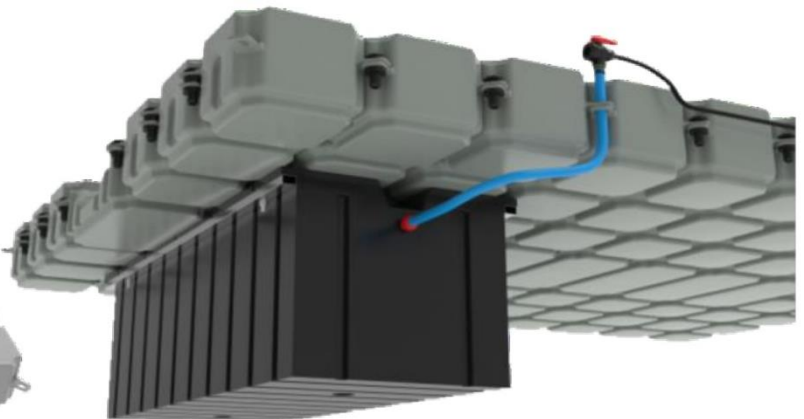

[www.esc.guide/bulldock](http://www.esc.guide/bulldock)

**We Build Your Desires**

<https://www.esc.guide/post/bulldock-the-floating-piers>



[www.esc.guide/bulldock](http://www.esc.guide/bulldock)

**BULLDOCK / Case Study: Razelm Luxury Resort**

<https://www.esc.guide/post/bulldock-case-study-razelm-luxury-resort>

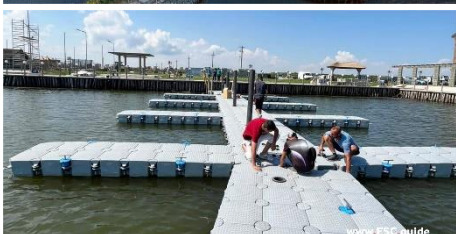

[www.esc.guide/bulldock](http://www.esc.guide/bulldock)

### BULLDOCK / Case Study: The Floating Island

<https://www.esc.guide/post/bulldock-case-study-the-floating-island>

